

GENERAL DESCRIPTION

The SGM05HU1AL is designed to protect voltage sensitive components from ESD. Excellent clamping capability, low leakage, high peak pulse current handling capability and fast response time provide best in class protection on designs that are exposed to ESD. Because of its small size, it is suited for use in cellular phones, tablets, digital cameras and many other portable applications where board space comes at a premium.

FEATURES

- Low Clamping Voltage
- Low Leakage
- Small Package: UTDFN-1×0.6-2BL
- Protection for the Following IEC Standards:
 - IEC 61000-4-2 Level 4: ±30kV Contact Discharge
 - IEC 61000-4-5 (Lightning) 43A (8/20µs)
- These Devices are Pb-Free, Halogen Free/BFR Free and are RoHS Compliant

APPLICATIONS

USB VBUS and CC Line Protection
 Microphone Line Protection
 GPIO Protection

ABSOLUTE MAXIMUM RATINGS

PARAMETER	SYMBOL	VALUE	UNITS
Peak Pulse Current ($t_p = 8/20\mu s$)	I_{PP}	43	A
ESD IEC 61000-4-2 (Air)	V_{ESD}	±30	kV
ESD IEC 61000-4-2 (Contact)		±30	
Operating Temperature Range	T_J	-40 to +125	°C
Storage Temperature Range	T_{STG}	-55 to +150	°C
Lead Temperature (Soldering, 10s)		+260	°C

Stresses exceeding those listed in Maximum Ratings may damage the device. If any of these limits are exceeded, device functionality should not be assumed, damage may occur and reliability may be affected.

PRODUCT SUMMARY

V_{RWM} (MAX)	I_{PP} (TYP)	C_{IN} (TYP)
5.5V	43A	100pF

PIN CONFIGURATION

(TOP VIEW)

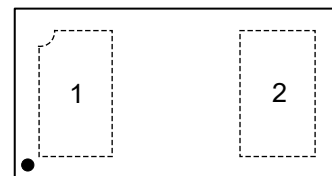

UTDFN-1×0.6-2BL

EQUIVALENT CIRCUIT

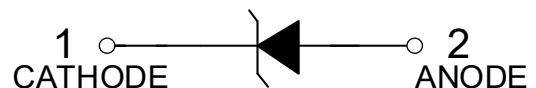

PACKAGE/ORDERING INFORMATION

MODEL	PACKAGE DESCRIPTION	SPECIFIED TEMPERATURE RANGE	ORDERING NUMBER	PACKAGE MARKING	PACKING OPTION
SGM05HU1AL	UTDFN-1x0.6-2BL	-40°C to +125°C	SGM05HU1ALXUGY2G/TR	00X	Tape and Reel, 10000

MARKING INFORMATION

NOTE: X = Date Code.

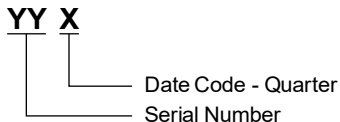

Green (RoHS & HSF): SG Micro Corp defines "Green" to mean Pb-Free (RoHS compatible) and free of halogen substances. If you have additional comments or questions, please contact your SGMICRO representative directly.

DISCLAIMER

SG Micro Corp reserves the right to make any change in circuit design, or specifications without prior notice.

ELECTRICAL PARAMETERS

SYMBOL	PARAMETER
I_{PP}	Maximum Reverse Peak Pulse Current
V_C	Clamping Voltage @ I_{PP}
V_{RWM}	Working Peak Reverse Voltage
I_R	Maximum Reverse Leakage Current @ V_{RWM}
V_{BR}	Breakdown Voltage @ I_T
I_T	Test Current

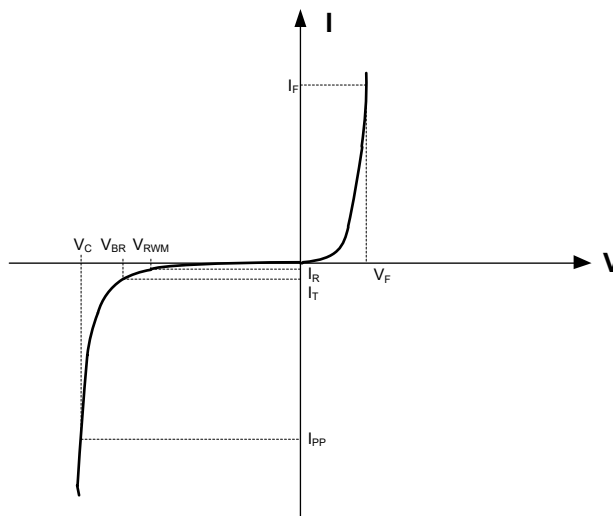

ELECTRICAL CHARACTERISTICS

(T_A = +25°C, unless otherwise noted.)

PARAMETER	SYMBOL	CONDITIONS	MIN	TYP	MAX	UNITS
Reverse Working Voltage	V _{RWM}	I/O pin to GND			5.5	V
Breakdown Voltage	V _{BR}	I _T = 1mA, I/O pin to GND	5.7		9.1	V
Reverse Leakage Current	I _R	V _{RWM} = 5V, I/O pin to GND			1	μA
Clamping Voltage TLP	V _C	I _{PP} = 8A, IEC 61000-4-2 level 2 equivalent (±4kV contact, ±8kV air)		6.9		V
		I _{PP} = 16A, IEC 61000-4-2 level 4 equivalent (±8kV contact, ±15kV air)		7.0		
Reverse Peak Pulse Current	I _{PP}	IEC 61000-4-5 (8 × 20μs)	43			A
Clamping Voltage 8 × 20μs Waveform	V _C	I _{PP} = 43A		10.1	12.1	V
Dynamic Resistance	R _{DYN}	100ns TLP		0.0125		Ω
Junction Capacitance	C _J	V _R = 0V, f = 1MHz		100	130	pF

NOTES:

1. Non-repetitive current pulse 8/20μs exponential decay waveform according to IEC 61000-4-5, 2Ω source impedance.
2. Non-repetitive current pulse, Transmission Line Pulse (TLP) t_p = 100ns; square pulse.

Positive 8kV:

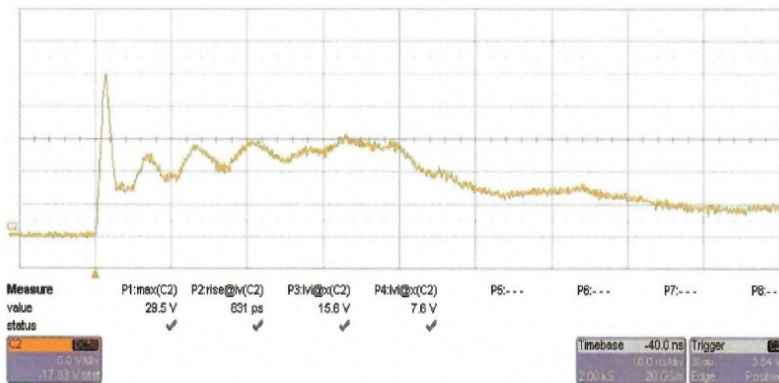

Figure 1. Typical Pulses ESD 8kV Contact per IEC 61000-4-2

Negative 8kV:

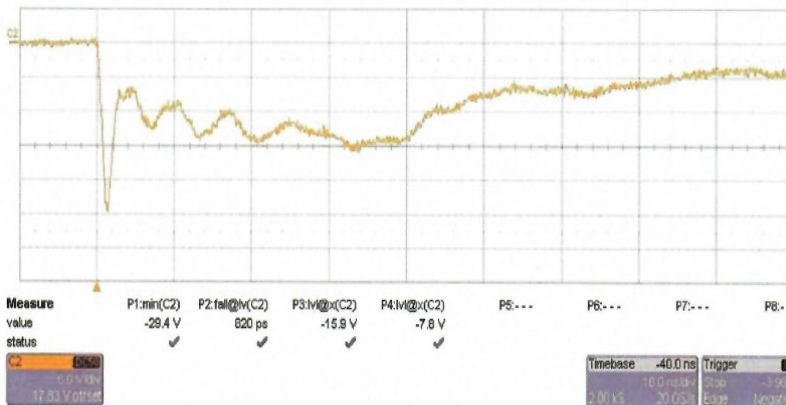
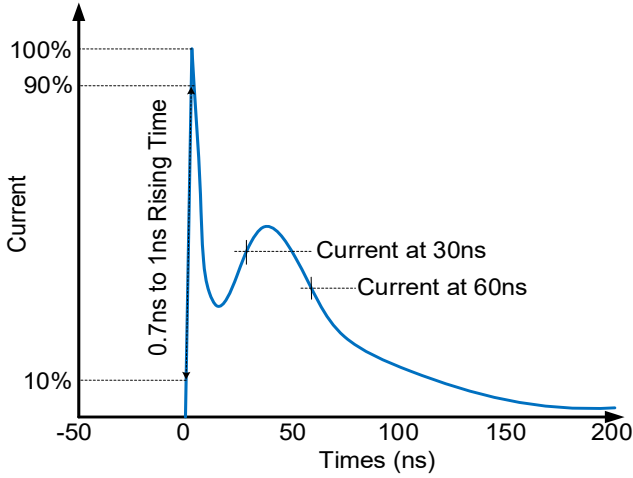

Figure 2. Typical Pulses ESD -8kV Contact per IEC 61000-4-2

TYPICAL PERFORMANCE CHARACTERISTICS

ESD pulse waveform per IEC 61000-4-2



8/20µs waveform per IEC 61000-4-5

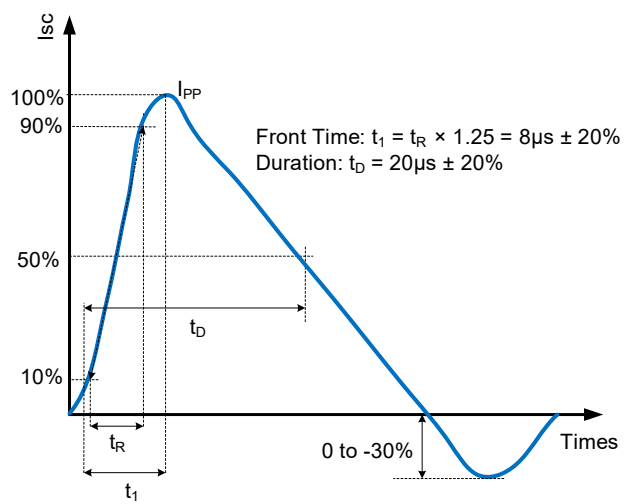

TLP_Pin1 (+) to Pin2 (-)

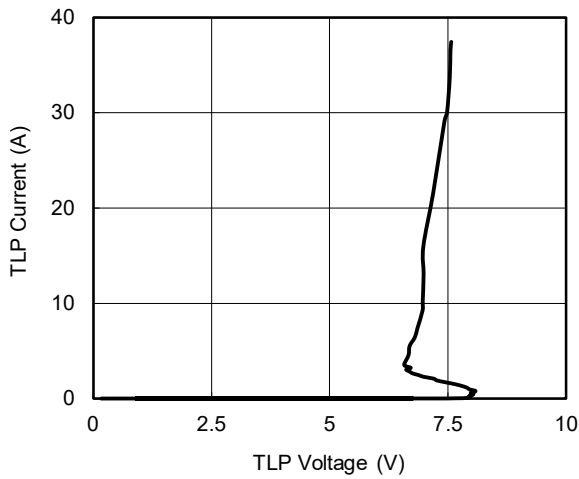

TLP_Pin1 (-) to Pin2 (+)

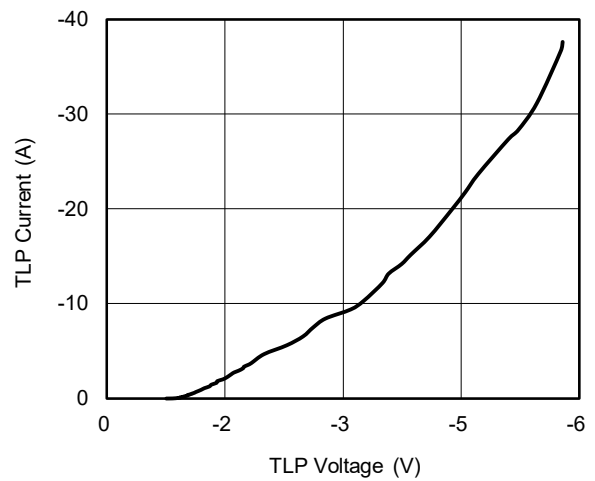

IV Curve

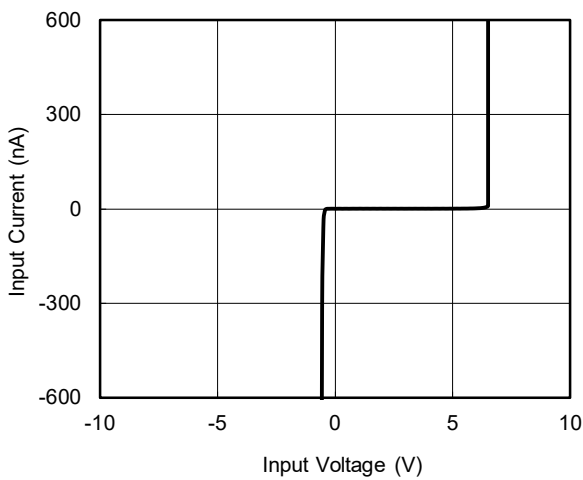

Capacitance vs. Reverse Voltage

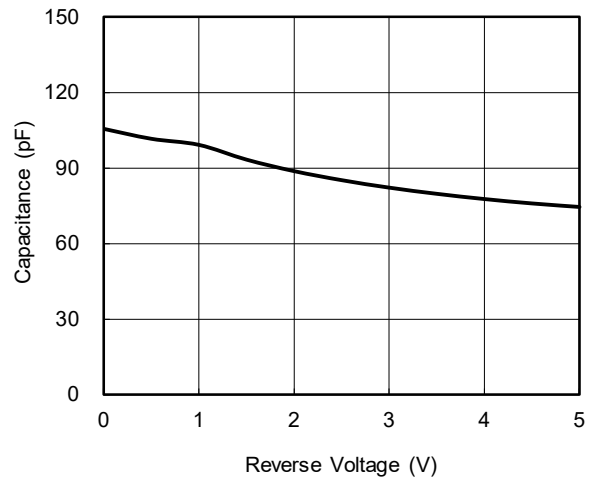

TYPICAL PERFORMANCE CHARACTERISTICS (continued)

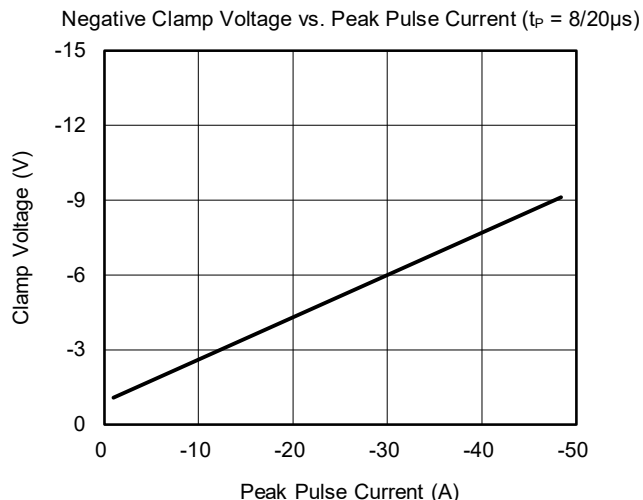
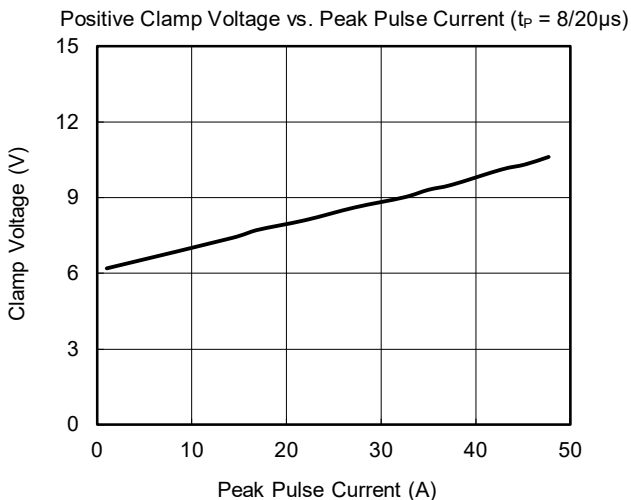

APPLICATION INFORMATION

The TVS is designed to provide a bidirectional line for dissipating ESD events on high-speed signal. The TVS is suitable for lines with positive and negative signal polarity relative to the ground.

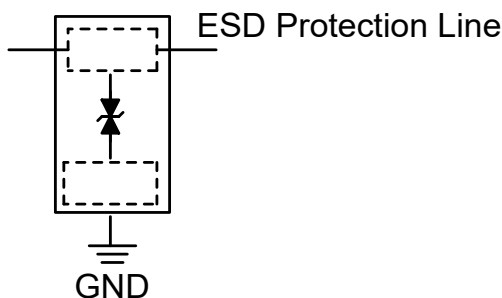

The following guidelines are recommended:

1. TVS Placement

Place the TVS as close to the input connector as possible.

2. TVS's Trace Layout

- Avoid running protected traces in parallel with unprotected traces.
- Minimize the path length between the TVS and the protected line.
- Minimize parallel signal path length.
- Route the protected traces as straight as possible.

3. GND Layout

- Avoid using a common ground point shared with the TVS transient return path.
- Minimize the length of the TVS transient return path to ground.
- Use ground vias as close as possible to the TVS transient return to ground.

REVISION HISTORY

NOTE: Page numbers for previous revisions may differ from page numbers in the current version.

Changes from Original (AUGUST 2024) to REV.A	Page
Changed from Product Preview to Production Data.....	All

PACKAGE OUTLINE DIMENSIONS

UTDFN-1x0.6-2BL

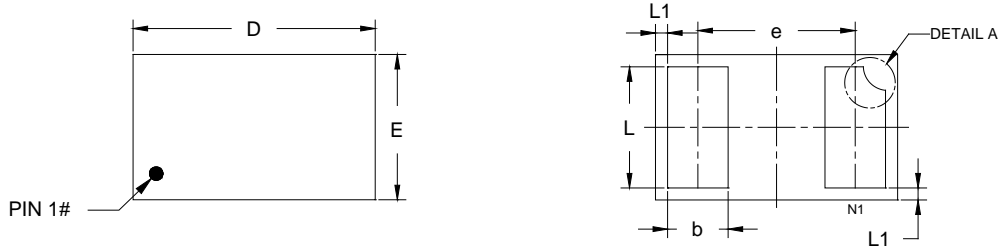

TOP VIEW

BOTTOM VIEW

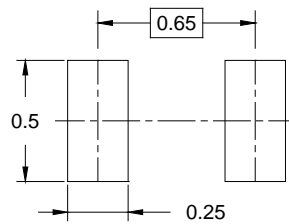
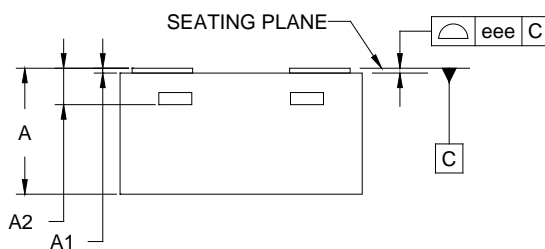

SIDE VIEW

RECOMMENDED LAND PATTERN (Unit: mm)

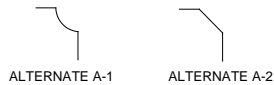

DETAIL A
ALTERNATE PIN1
CONSTRUCTION

Symbol	Dimensions In Millimeters		
	MIN	NOM	MAX
A	0.450	-	0.550
A1	0.000	-	0.050
A2	0.150 REF		
b	0.200	-	0.300
D	0.950	-	1.050
E	0.550	-	0.650
e	0.650 BSC		
L	0.450	-	0.550
L1	0.050 REF		
eee	0.080		

NOTE: This drawing is subject to change without notice.

PACKAGE INFORMATION

TAPE AND REEL INFORMATION

REEL DIMENSIONS

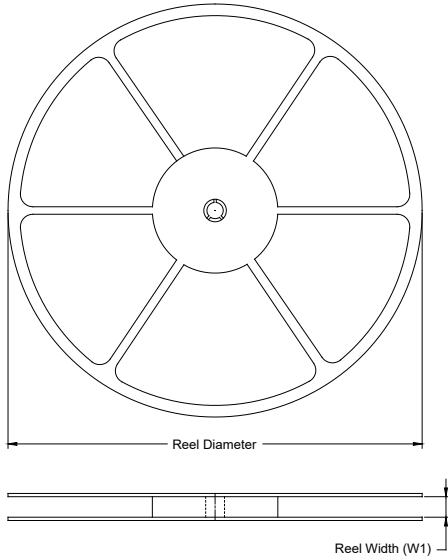

TAPE DIMENSIONS

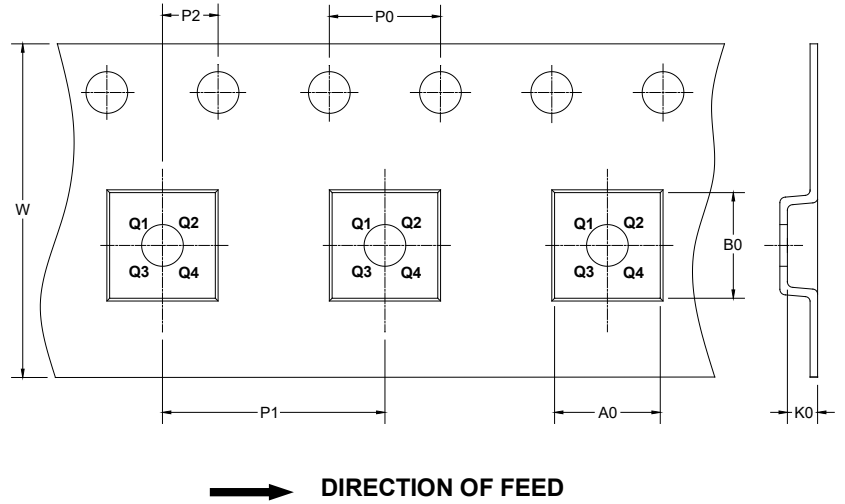

NOTE: The picture is only for reference. Please make the object as the standard.

KEY PARAMETER LIST OF TAPE AND REEL

Package Type	Reel Diameter	Reel Width W1 (mm)	A0 (mm)	B0 (mm)	K0 (mm)	P0 (mm)	P1 (mm)	P2 (mm)	W (mm)	Pin1 Quadrant
UTDFN-1×0.6-2BL	7"	8.6	0.70	1.15	0.57	4.0	2.0	2.0	8.0	Q1

DD0001

PACKAGE INFORMATION

CARTON BOX DIMENSIONS

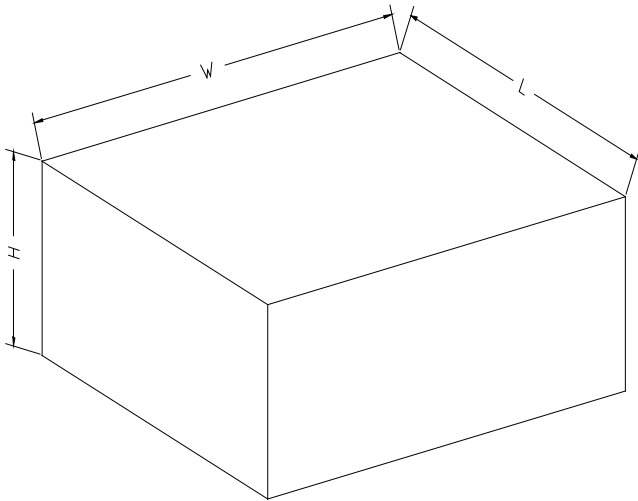

NOTE: The picture is only for reference. Please make the object as the standard.

KEY PARAMETER LIST OF CARTON BOX

Reel Type	Length (mm)	Width (mm)	Height (mm)	Pizza/Carton
7" (Option)	368	227	224	8
7"	442	410	224	18

DD0002