

### GENERAL DESCRIPTION

The SGM11103E is a single-pole/triple-throw (SP3T) antenna switch, which supports from 0.1GHz to 3GHz. The device features low insertion loss and high isolation, which make it suitable for high linearity receiving and 2G/3G/4G transmitting/receiving (TRx) applications. It also has the advantage of high linearity performance. The SGM11103E is not subject to cellular interference and is applied to multi-mode and multi-band LTE mobile phones.

The SGM11103E has the ability to integrate SP3T RF switch and GPIO controller on an SOI chip. Internal driver and decoder for switch control signals are offered by the GPIO controller, which makes it flexible in RF path band and routing selection.

No external DC blocking capacitors required on the RF paths as long as no external DC voltage is applied, which can save PCB area and cost.

The SGM11103E is available in a Green ULGA-1.1×1.1-9L package.

### APPLICATIONS

Receiving Band Switching and Pre-PA Switching  
 2G/3G/4G Transmitting/Receiving (TRx)

### FEATURES

- **Supply Voltage Range: 2.5V to 3.4V**
- **GPIO Controller**
- **Low Insertion Loss: 0.65dB (TYP) at 2.7GHz**
- **Operating Frequency Range: 0.1GHz to 3GHz**
- **High Isolation: 23dB (MIN) at 2.7GHz**
- **Advanced Silicon-On-Insulator (SOI) Process**
- **No External DC Blocking Capacitors Required**
- **Available in a Green ULGA-1.1×1.1-9L Package**

### BLOCK DIAGRAM

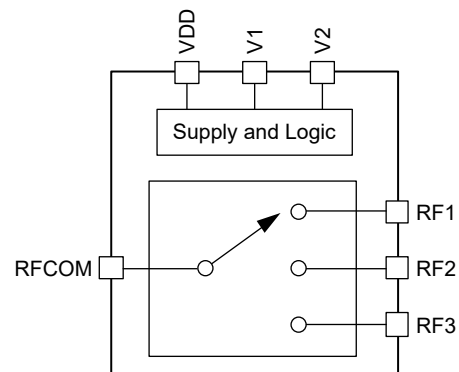

Figure 1. SGM11103E Block Diagram

**PACKAGE/ORDERING INFORMATION**

MODEL	PACKAGE DESCRIPTION	SPECIFIED TEMPERATURE RANGE	ORDERING NUMBER	PACKAGE MARKING	PACKING OPTION
SGM11103E	ULGA-1.1×1.1-9L	-40°C to +85°C	SGM11103EYULA9G/TR	1Q	Tape and Reel, 3000

**MARKING INFORMATION**

NOTE: Fixed character for 1Q.

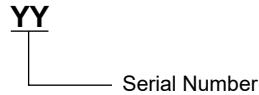

Green (RoHS & HSF): SG Micro Corp defines "Green" to mean Pb-Free (RoHS compatible) and free of halogen substances. If you have additional comments or questions, please contact your SGMICRO representative directly.

**ABSOLUTE MAXIMUM RATINGS**

Supply Voltage, $V_{DD}$ .....	3.6V
Control Voltage, (V1 and V2 Pins), $V_{CTL}$ .....	3.6V
RF Input Power, $P_{IN}$ .....	36.5dBm
Junction Temperature.....	+150°C
Storage Temperature Range .....	-55°C to +150°C
Lead Temperature (Soldering, 10s).....	+260°C
ESD Susceptibility	
HBM.....	1000V

**RECOMMENDED OPERATING CONDITIONS**

Operating Temperature Range .....	-40°C to +85°C
Operating Frequency Range.....	0.1GHz to 3GHz
Supply Voltage, $V_{DD}$ .....	2.5V to 3.4V
Control Voltage High, $V_{CTL\_H}$ .....	1.66V to 3.4V
Control Voltage Low, $V_{CTL\_L}$ .....	0V to 0.45V

**OVERSTRESS CAUTION**

Stresses beyond those listed in Absolute Maximum Ratings may cause permanent damage to the device. Exposure to absolute maximum rating conditions for extended periods may affect reliability. Functional operation of the device at any conditions beyond those indicated in the Recommended Operating Conditions section is not implied.

**ESD SENSITIVITY CAUTION**

This integrated circuit can be damaged if ESD protections are not considered carefully. SGMICRO recommends that all integrated circuits be handled with appropriate precautions. Failure to observe proper handling and installation procedures can cause damage. ESD damage can range from subtle performance degradation to complete device failure. Precision integrated circuits may be more susceptible to damage because even small parametric changes could cause the device not to meet the published specifications.

**DISCLAIMER**

SG Micro Corp reserves the right to make any change in circuit design, or specifications without prior notice.

## PIN CONFIGURATION

(TOP VIEW)

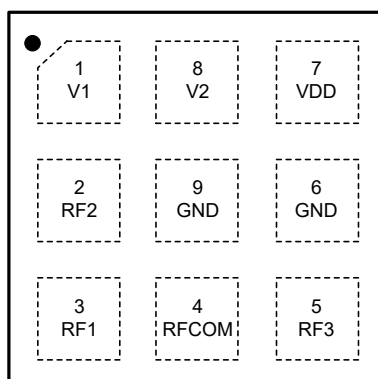

ULGA-1.1×1.1-9L

## PIN DESCRIPTION

PIN	NAME	FUNCTION
1	V1	DC Control Voltage 1.
2	RF2	RF Port 2.
3	RF1	RF Port 1.
4	RFCOM	RF Common Port.
5	RF3	RF Port 3.
6, 9	GND	Ground.
7	VDD	DC Power Supply.
8	V2	DC Control Voltage 2.

## LOGIC TRUTH TABLE

VDD	V1	V2	ACTIVE PATH
H	H	L	RFCOM to RF1
H	H	H	RFCOM to RF2
H	L	H	RFCOM to RF3
H	L	L	Isolation

**ELECTRICAL CHARACTERISTICS**(V<sub>DD</sub> = 2.5V to 3.4V, T<sub>A</sub> = +25°C, P<sub>IN</sub> = 0dBm, 50Ω, typical values are at V<sub>DD</sub> = 2.8V, unless otherwise noted.)

PARAMETER	SYMBOL	CONDITIONS	MIN	TYP	MAX	UNITS
<b>DC Specifications</b>						
Supply Voltage	V <sub>DD</sub>		2.5	2.8	3.4	V
Supply Current	I <sub>DD</sub>			40	80	μA
Control Voltage	V <sub>CTL_H</sub>	High	1.66	1.8	3.4	V
	V <sub>CTL_L</sub>	Low	0		0.45	
Control Current	I <sub>CTL</sub>	V <sub>CTL</sub> = 0V		3	8	μA
Switching Time	t <sub>sw</sub>	50% of control voltage to 90% of RF power		2	5	μs
Turn-On Time	t <sub>ON</sub>	Time from V <sub>DD</sub> = 0V to part on and RF at 90%		10	15	μs
<b>RF Specifications</b>						
Insertion Loss (RFCOM to All RF Ports)	IL	0.1GHz to 1.0GHz		0.45	0.68	dB
		1.0GHz to 2.0GHz		0.55	0.77	
		2.0GHz to 2.7GHz		0.65	0.96	
Isolation (RFCOM to All RF Ports)	ISO	0.1GHz to 1.0GHz	34	42		dB
		1.0GHz to 2.0GHz	27	35		
		2.0GHz to 2.7GHz	23	25		
Input Return Loss (RFCOM to All RF Ports)	RL	0.1GHz to 1.0GHz	16	20		dB
		1.0GHz to 2.0GHz	13	16		
		2.0GHz to 2.7GHz	11	15		
0.1dB Compression Point (RFCOM to All RF Ports)	P <sub>0.1dB</sub>	0.1GHz to 3GHz		36.5		dBm
2 <sup>nd</sup> Harmonics	2f <sub>0</sub>	P <sub>IN</sub> = 26dBm, 0.1GHz to 3GHz		95		dBc
3 <sup>rd</sup> Harmonics	3f <sub>0</sub>	P <sub>IN</sub> = 26dBm, 0.1GHz to 3GHz		90		dBc

TYPICAL APPLICATION CIRCUIT

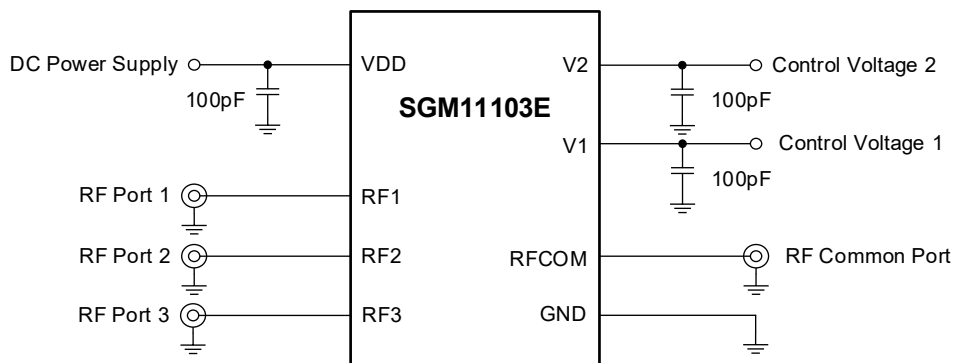

Figure 2. SGM11103E Typical Application Circuit

EVALUATION BOARD LAYOUT

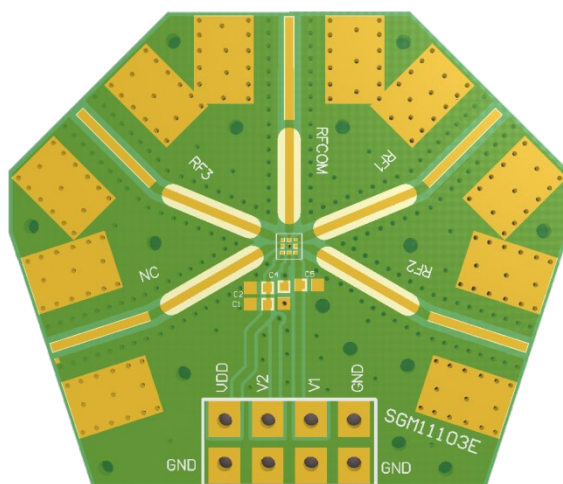

Figure 3. SGM11103E Evaluation Board Layout

**REVISION HISTORY**

NOTE: Page numbers for previous revisions may differ from page numbers in the current version.

<b>NOVEMBER 2023 – REV.A.1 to REV.A.2</b>	<b>Page</b>
Update Electrical Characteristics section .....	4

---

<b>APRIL 2022 – REV.A to REV.A.1</b>	<b>Page</b>
Update Evaluation Board Layout section .....	5

---

<b>Changes from Original (JANUARY 2022) to REV.A</b>	<b>Page</b>
Changed from product preview to production data .....	All

---

PACKAGE OUTLINE DIMENSIONS

ULGA-1.1x1.1-9L

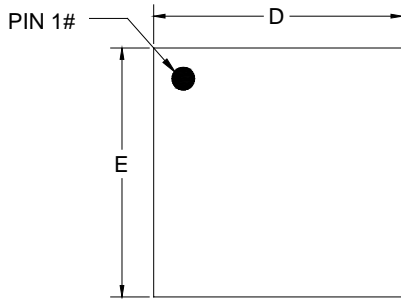

TOP VIEW

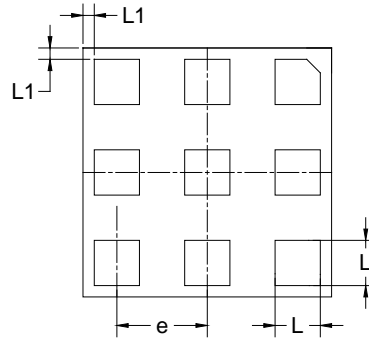

BOTTOM VIEW

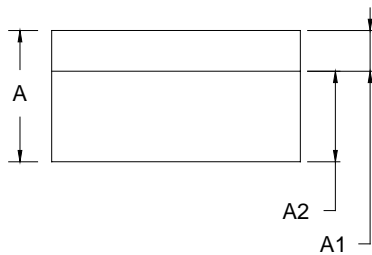

SIDE VIEW

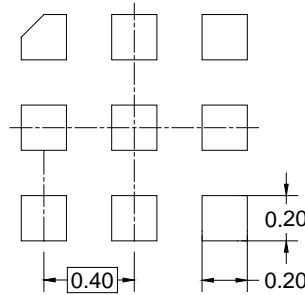

RECOMMENDED LAND PATTERN (Unit: mm)

Symbol	Dimensions In Millimeters		
	MIN	MOD	MAX
A	0.530	0.580	0.630
A1	0.150	0.180	0.210
A2	0.400 BSC		
D	1.000	1.100	1.200
E	1.000	1.100	1.200
e	0.400 BSC		
L	0.150	0.200	0.250
L1	0.050 REF		

NOTE: This drawing is subject to change without notice.

TAPE AND REEL INFORMATION

REEL DIMENSIONS



TAPE DIMENSIONS



NOTE: The picture is only for reference. Please make the object as the standard.

KEY PARAMETER LIST OF TAPE AND REEL

Package Type	Reel Diameter	Reel Width W1 (mm)	A0 (mm)	B0 (mm)	K0 (mm)	P0 (mm)	P1 (mm)	P2 (mm)	W (mm)	Pin1 Quadrant
ULGA-1.1×1.1-9L	7"	8.6	1.26	1.26	0.72	4.0	4.0	2.0	8.0	Q2

000001



# PACKAGE INFORMATION

## CARTON BOX DIMENSIONS



NOTE: The picture is only for reference. Please make the object as the standard.

## KEY PARAMETER LIST OF CARTON BOX

Reel Type	Length (mm)	Width (mm)	Height (mm)	Pizza/Carton
7" (Option)	368	227	224	8
7"	442	410	224	18

DD0002