

GENERAL DESCRIPTION

The SGM6330 is a current-mode Buck regulator with an internal power MOSFET. It can operate at an input voltage from 4.5V to 18V with 0.8V to 15V adjustable output. A fixed 385kHz switching frequency helps the device to provide fast transient response. It also offers a 3A continuous output current and a peak efficiency of 94% with excellent load and line regulations.

In off mode, the voltage regulator's supply current is less than 18µA. This device also equips the under-voltage lockout (UVLO), cycle-by-cycle current limit and thermal shutdown features. The internal soft-start function and the external adjustable soft-start function help the device to limit the inrush current and prevent output voltage overshooting.

The SGM6330 is available in a Green SOIC-8 (Exposed Pad) package. It operates over an ambient temperature range of -40°C to +85°C.

FEATURES

- 4.5V to 18V Input Voltage Range
- 0.8V to 15V Adjustable Output
- 3A Output Current
- Up to 94% High Efficiency
- Fixed 385kHz Switching Frequency
- Less than 18µA Shutdown Supply Current
- 100mΩ Internal Power MOSFET Switch
- Under-Voltage Lockout (UVLO)
- Thermal Shutdown Protection
- Stable with Low ESR Ceramic Capacitors
- -40°C to +85°C Operating Temperature Range
- Available in a Green SOIC-8 (Exposed Pad) Package

APPLICATIONS

- Distributed Power Systems
- Battery Chargers
- Flat Panel TVs and Set-Top Boxes
- DVD, PVR
- Pre-Regulator for Linear Regulators

TYPICAL APPLICATION

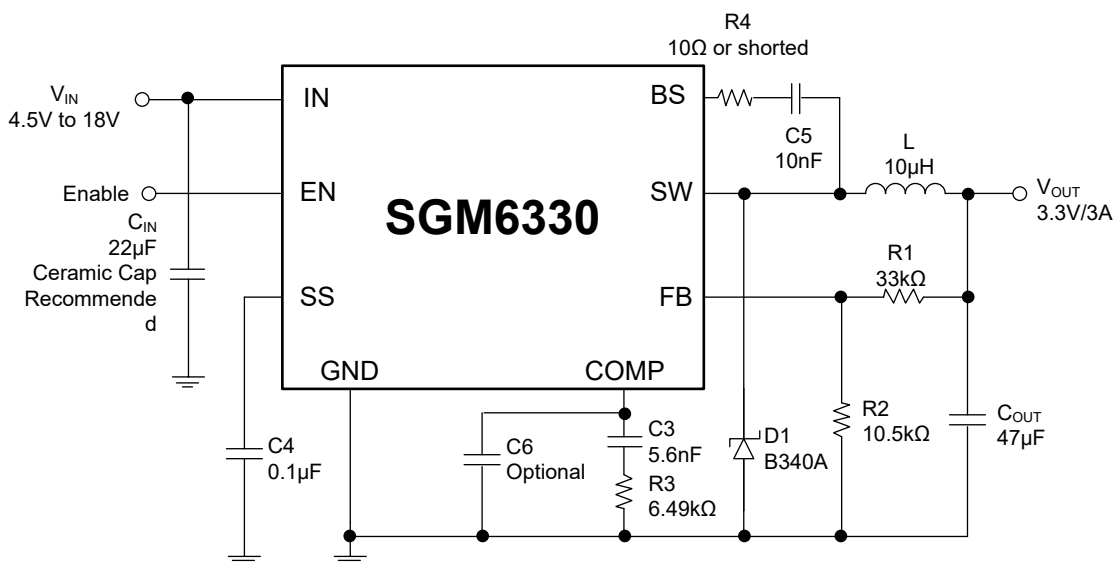

Figure 1. Typical Application Circuit

PACKAGE/ORDERING INFORMATION

MODEL	PACKAGE DESCRIPTION	SPECIFIED TEMPERATURE RANGE	ORDERING NUMBER	PACKAGE MARKING	PACKING OPTION
SGM6330	SOIC-8 (Exposed Pad)	-40°C to +85°C	SGM6330YPS8G/TR	SGM 6330YPS8 XXXXXX	Tape and Reel, 2500

MARKING INFORMATION

NOTE: XXXXX = Date Code, Trace Code and Vendor Code.

XXXXX

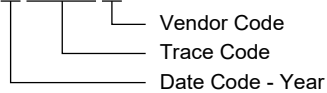

Green (RoHS & HSF): SG Micro Corp defines "Green" to mean Pb-Free (RoHS compatible) and free of halogen substances. If you have additional comments or questions, please contact your SGMICRO representative directly.

ABSOLUTE MAXIMUM RATINGS

- Supply Voltage, V_{IN} -0.3V to 20V
- SW Voltage, V_{SW}-0.5V to $V_{IN} + 0.3V$
- Boost Voltage, V_{BS} $V_{SW} - 0.3V$ to $V_{SW} + 6V$
- All Other Pins..... -0.3V to 6V
- Package Thermal Resistance
- SOIC-8 (Exposed Pad), θ_{JA} 50°C/W
- Junction Temperature+150°C
- Storage Temperature Range.....-65°C to +150°C
- Lead Temperature (Soldering, 10s)+260°C
- ESD Susceptibility
- HBM..... 4000V
- CDM 250V

RECOMMENDED OPERATING CONDITIONS

- Operating Ambient Temperature Range..... -40°C to +85°C

OVERSTRESS CAUTION

Stresses beyond those listed in Absolute Maximum Ratings may cause permanent damage to the device. Exposure to absolute maximum rating conditions for extended periods may affect reliability. Functional operation of the device at any conditions beyond those indicated in the Recommended Operating Conditions section is not implied.

ESD SENSITIVITY CAUTION

This integrated circuit can be damaged if ESD protections are not considered carefully. SGMICRO recommends that all integrated circuits be handled with appropriate precautions. Failure to observe proper handling and installation procedures can cause damage. ESD damage can range from subtle performance degradation to complete device failure. Precision integrated circuits may be more susceptible to damage because even small parametric changes could cause the device not to meet the published specifications.

DISCLAIMER

SG Micro Corp reserves the right to make any change in circuit design, or specifications without prior notice.

PIN CONFIGURATION

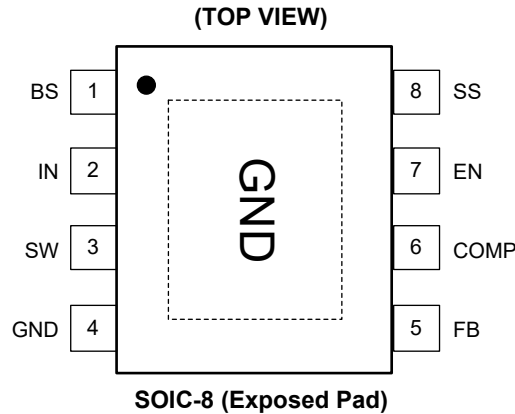

PIN DESCRIPTION

PIN	NAME	FUNCTION
1	BS	High-side Gate Drive Boost Input. This pin powers the driver for the high-side N-Channel MOSFET switch. A 10nF or greater capacitor is placed between SW and BS to supply the high-side switch. Connect a 10Ω resistor from SW to BS to reduce SW spike voltage.
2	IN	Power Input. Bypass this pin to GND with a large enough capacitor to reduce the noise.
3	SW	Switching Output. Connect the output LC filter from SW to the output load. A capacitor between SW and BS is required to power the high-side switch.
4	GND	Ground.
5	FB	Feedback Input. The voltage at this pin is programmed to 0.8V. A resistor divider is used and put between the output and ground to set output voltage.
6	COMP	Compensation Node. The RC network in series from COMP to GND compensates regulating control loop. In some cases, an additional capacitor from COMP to GND is used.
7	EN	Enable Input. Pull EN high to enable the device, and pull EN low to disable it. When the device is turned off, the output voltage is disabled. In automatic startup condition, EN pin is left unconnected.
8	SS	Soft-Start Control Input. A capacitor is placed between SS to GND to set the soft-start period. A 0.1μF capacitor programs the soft-start period to 10ms. If disable this feature, leave SS unconnected.
Exposed Pad	GND	Power Ground Exposed Pad.

ELECTRICAL CHARACTERISTICS

(V_{IN} = 2.7V to 5.5V, V_{OUT} = 9V. Full = -40°C to +85°C, typical values are at T_J = +25°C, unless otherwise noted.)

PARAMETER	SYMBOL	CONDITIONS	MIN	TYP	MAX	UNITS
Input Voltage Range	V _{IN}		4.5		18	V
Feedback Voltage	V _{FB}		0.776	0.8	0.824	V
Shutdown Supply Current	I _{SHDN}	V _{EN} = 0V		10	18	μA
Quiescent Supply Current	I _Q	V _{EN} = 2.6V, V _{FB} = 1V		0.8	1.7	mA
High-side Switch (M1) On-Resistance	R _{ONH}			100		mΩ
Low-side Switch (M2) On-Resistance	R _{ONL}			10		Ω
Error Amplifier Transconductance	G _{EA}	ΔV _{FB} = ±12.5mV	500	800	1120	μA/V
Error Amplifier Voltage Gain	A _{EA}			10000		V/V
SW Leakage Current	I _{LSW}	V _{EN} = 0V, V _{SW} = 0V			1	μA
Current Limit	I _{LIM}			4.2		A
Current Sense to COMP Transconductance	G _{CS}			6.2		A/V
Maximum Duty Cycle	D _{MAX}	V _{FB} = 0.6V		90		%
Minimum Duty Cycle	D _{MIN}	V _{FB} = 1V		0		%
EN Threshold Voltage	V _{IH}		1.2			V
EN Threshold Voltage	V _{IL}				0.4	V
EN Pull-Up Current		V _{EN} = 0V	0.8	1.4	2	μA
Oscillator Frequency	f _s		335	385	435	kHz
Short-Circuit Oscillator Frequency		V _{FB} = 0V	25	38	60	kHz
Under-Voltage Lockout Threshold		V _{IN} Rising	3.5	3.8	4.2	V
Under-Voltage Lockout Threshold Hysteresis				230		mV
Soft-Start Period		C _{SS} = 0.1μF		10		ms
Thermal Shutdown Temperature	T _{SHDN}			160		°C

TYPICAL PERFORMANCE CHARACTERISTICS

At $T_J = +25^\circ\text{C}$, $V_{IN} = 3.6\text{V}$, $V_{OUT} = 9\text{V}$, unless otherwise noted.

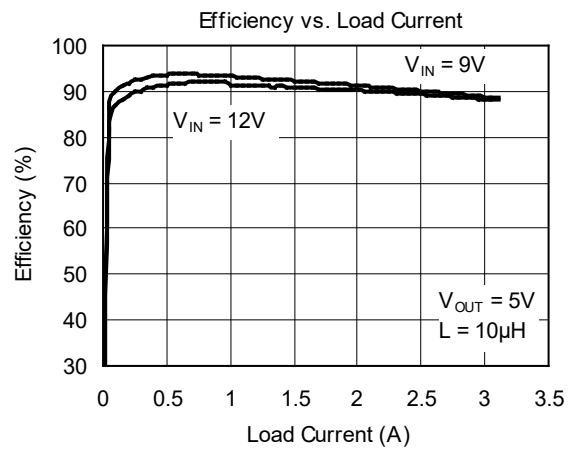
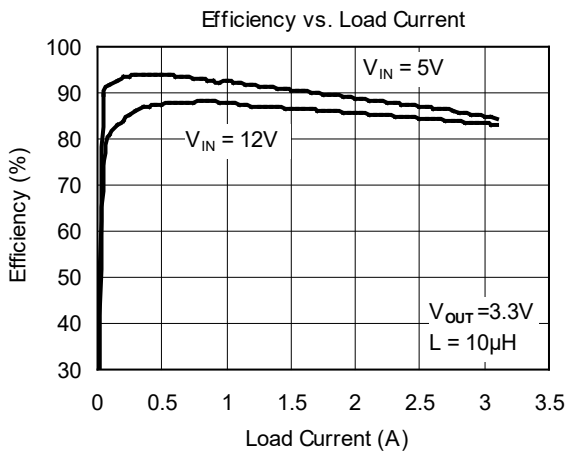
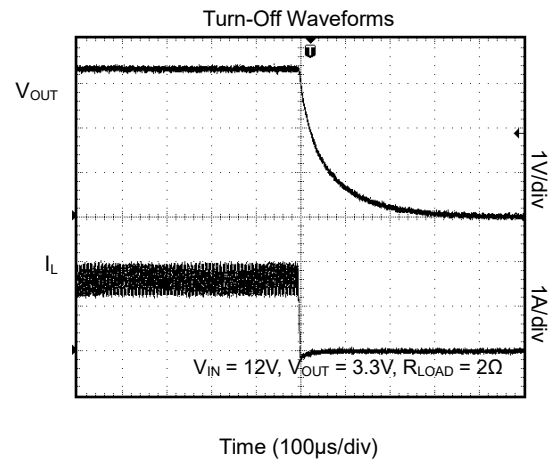
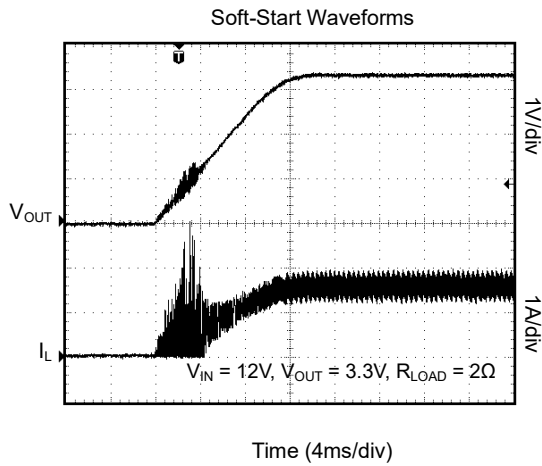
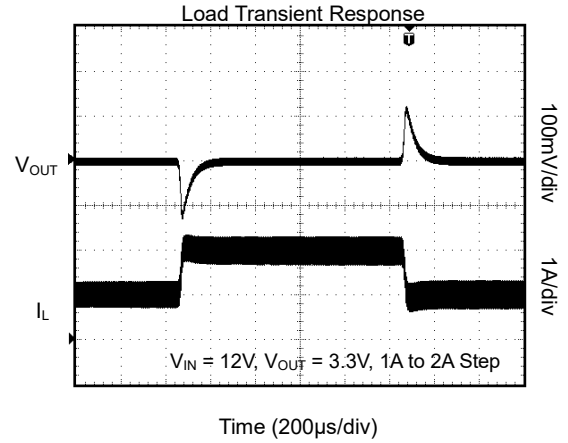
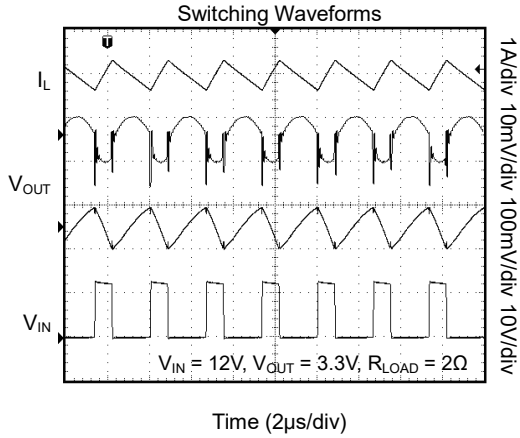

TYPICAL PERFORMANCE CHARACTERISTICS (continued)

At $T_J = +25^\circ\text{C}$, $V_{IN} = 3.6\text{V}$, $V_{OUT} = 9\text{V}$, unless otherwise noted.

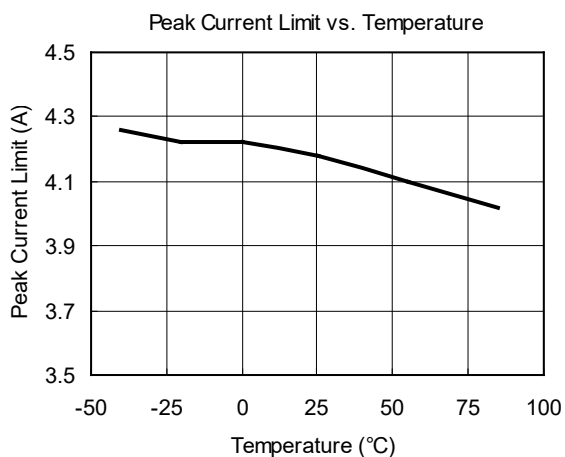
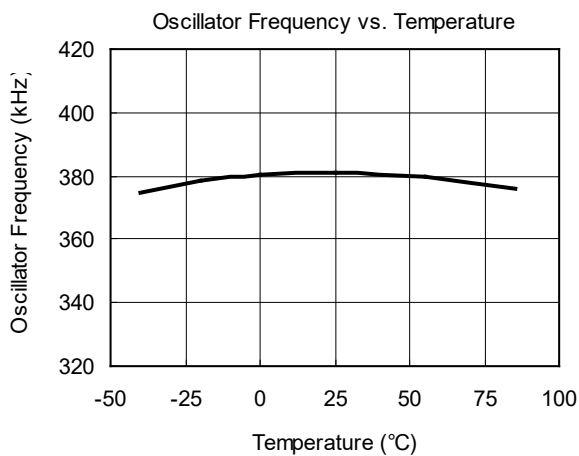
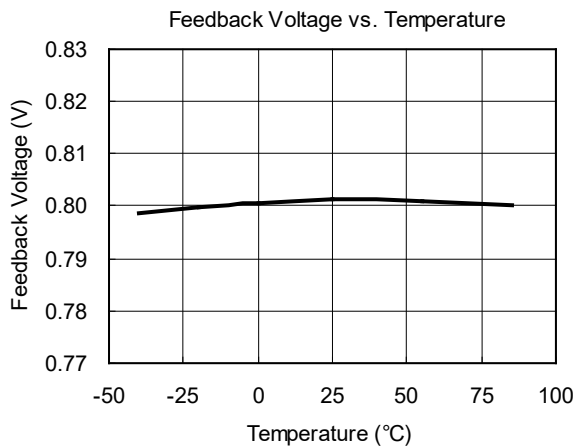

REVISION HISTORY

NOTE: Page numbers for previous revisions may differ from page numbers in the current version.

	Page
OCTOBER 2023 – REV.A.4 to REV.B	
Updated GENERAL DESCRIPTION section.....	1
JULY 2015 – REV.A.3 to REV.A.4	
Changed TYPICAL APPLICATION and Input Capacitor	1, 8
JULY 2014 – REV.A.2 to REV.A.3	
Added a 10Ω resistor between SW and BS pin in application circuit	1, 3, 10
APRIL 2014 – REV.A.1 to REV.A.2	
Changed shutdown supply current and electrical characteristics.....	1, 4
JANUARY 2013 – REV.A to REV.A.1	
Updated the Soft-Start Section	7
Changes from Original (NOVEMBER 2012) to REV.A	
Changed from product preview to production data.....	All

PACKAGE OUTLINE DIMENSIONS

SOIC-8 (Exposed Pad)

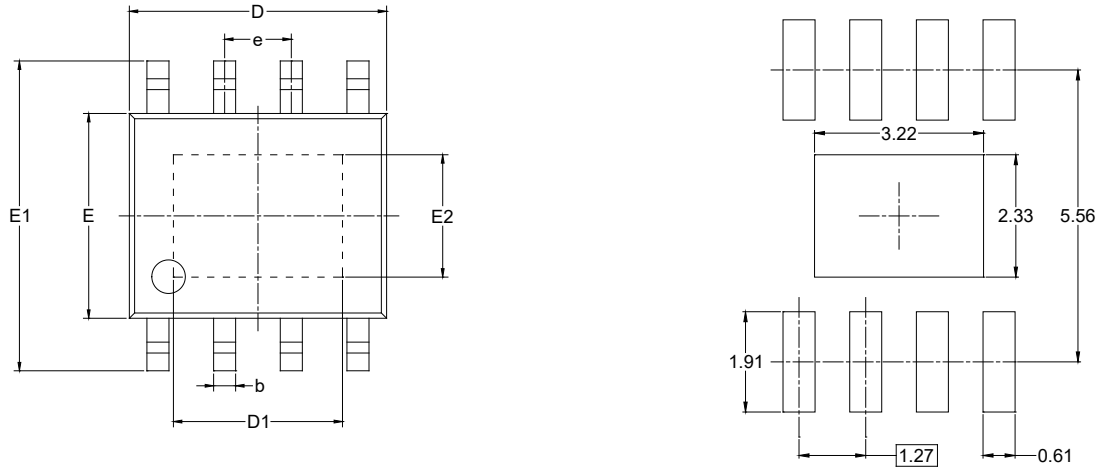

RECOMMENDED LAND PATTERN (Unit: mm)

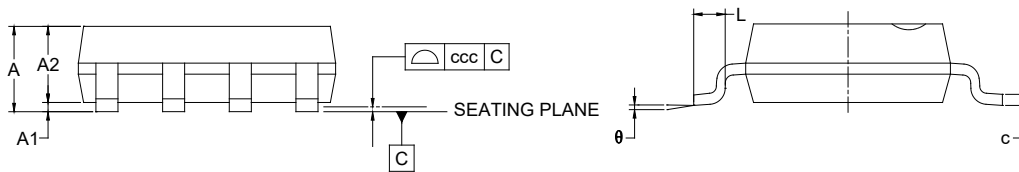

Symbol	Dimensions In Millimeters		
	MIN	MOD	MAX
A			1.700
A1	0.000	-	0.150
A2	1.250	-	1.650
b	0.330	-	0.510
c	0.170	-	0.250
D	4.700	-	5.100
D1	3.020	-	3.420
E	3.800	-	4.000
E1	5.800	-	6.200
E2	2.130	-	2.530
e	1.27 BSC		
L	0.400	-	1.270
θ	0°	-	8°
ccc	0.100		

NOTES:

1. This drawing is subject to change without notice.
2. The dimensions do not include mold flashes, protrusions or gate burrs.
3. Reference JEDEC MS-012.

PACKAGE INFORMATION

TAPE AND REEL INFORMATION

REEL DIMENSIONS



TAPE DIMENSIONS



NOTE: The picture is only for reference. Please make the object as the standard.

KEY PARAMETER LIST OF TAPE AND REEL

Package Type	Reel Diameter	Reel Width W1 (mm)	A0 (mm)	B0 (mm)	K0 (mm)	P0 (mm)	P1 (mm)	P2 (mm)	W (mm)	Pin1 Quadrant
SOIC-8 (Exposed Pad)	13"	12.4	6.4	5.4	2.1	4.0	8.0	2.0	12.0	Q1

000001

PACKAGE INFORMATION

CARTON BOX DIMENSIONS



NOTE: The picture is only for reference. Please make the object as the standard.

KEY PARAMETER LIST OF CARTON BOX

Reel Type	Length (mm)	Width (mm)	Height (mm)	Pizza/Carton
13"	386	280	370	5

DD0002