

### GENERAL DESCRIPTION

The SGM432x is a precision programmable shunt voltage reference that can be used in many applications. It is a three-terminal adjustable-output device that can keep stable under all capacitive loads. It requires two external resistors in application to set the output voltage is to any value between  $V_{REF}$  and 36V. All versions have a maximum operating current of 100mA.

The SGM432x features low dynamic impedance, low noise, and low temperature coefficient to ensure a stable output voltage over a wide range of operating temperatures and currents. These high performances make it very suitable for multiple applications, such as precision audio components and flyback switching power supplies.

The SGM432x is available in Green SOT-89-3, SOT-23 and SOT-23-5 packages.

### FEATURES

- **Adjustable Output Voltage:**  $V_{REF}$  to 36V
- **Sink-Current Capability:** 1mA to 100mA
- **Reference Voltage Tolerance at +25°C:**
  - ◆ SGM432: 1% (Standard Grade)
  - ◆ SGM432B: 0.5% (B Grade)
- **Output Impedance:** 0.1Ω (TYP)
- **Temperature Drift:** 5mV (TYP)
- **High Stability under Capacitive Load**
- **Low Output Noise**
- **-40°C to +125°C Operating Temperature Range**
- **Available in Green SOT-89-3, SOT-23 and SOT-23-5 Packages**

### APPLICATIONS

- Portable, Battery-Powered Equipment
- Voltage Monitoring
- Flyback Switching Power Supplies
- Instrumentation
- Product Testing
- Precision Audio Components

### TYPICAL APPLICATION

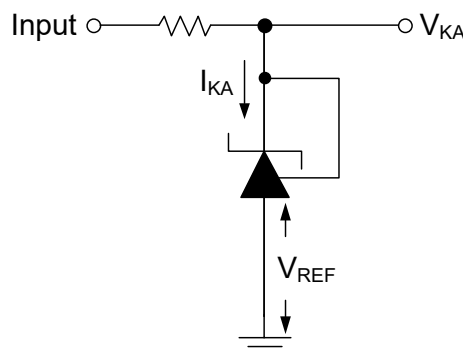

Figure 1. Typical Application Circuit

**PACKAGE/ORDERING INFORMATION**

| MODEL   | PACKAGE DESCRIPTION | SPECIFIED TEMPERATURE RANGE | ORDERING NUMBER | PACKAGE MARKING   | PACKING OPTION      |
|---------|---------------------|-----------------------------|-----------------|-------------------|---------------------|
| SGM432  | SOT-89-3            | -40°C to +125°C             | SGM432XK3G/TR   | SGM432X<br>XXXXX  | Tape and Reel, 1000 |
|         | SOT-23              | -40°C to +125°C             | SGM432XN3LG/TR  | CB7XX             | Tape and Reel, 3000 |
|         | SOT-23-5            | -40°C to +125°C             | SGM432XN5G/TR   | CJCXX             | Tape and Reel, 3000 |
| SGM432B | SOT-89-3            | -40°C to +125°C             | SGM432BXK3G/TR  | SGM432BX<br>XXXXX | Tape and Reel, 1000 |
|         | SOT-23              | -40°C to +125°C             | SGM432BXN3LG/TR | CYBXX             | Tape and Reel, 3000 |
|         | SOT-23-5            | -40°C to +125°C             | SGM432BXN5G/TR  | CY9XX             | Tape and Reel, 3000 |

**MARKING INFORMATION**

NOTE: XX = Date Code, XXXXX = Date Code, Trace Code and Vendor Code.

**SOT-23/SOT-23-5**

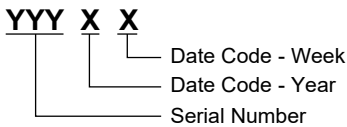

**SOT-89-3**

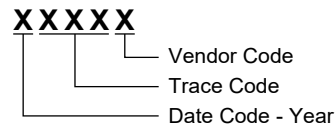

Green (RoHS & HSF): SG Micro Corp defines "Green" to mean Pb-Free (RoHS compatible) and free of halogen substances. If you have additional comments or questions, please contact your SGMICRO representative directly.

**ABSOLUTE MAXIMUM RATINGS**

- Cathode Voltage <sup>(1)</sup>, V<sub>KA</sub>..... 40V
- Package Thermal Resistance
- SOT-89-3, θ<sub>JA</sub> ..... 71°C/W
- SOT-23, θ<sub>JA</sub>..... 245°C/W
- SOT-23-5, θ<sub>JA</sub> ..... 210°C/W
- Junction Temperature .....+150°C
- Storage Temperature Range.....-65°C to +150°C
- Lead Temperature (Soldering, 10s) .....+260°C
- ESD Susceptibility
- HBM..... 4000V
- CDM ..... 1000V

**RECOMMENDED OPERATING CONDITIONS**

- Cathode Voltage, V<sub>KA</sub> ..... V<sub>REF</sub> to 36V
- Cathode Current, I<sub>KA</sub>.....1mA to 100mA
- Operating Junction Temperature Range .....-40°C to +125°C

NOTE:

1. All voltage values are with respect to ANODE, unless otherwise noted.

**OVERSTRESS CAUTION**

Stresses beyond those listed in Absolute Maximum Ratings may cause permanent damage to the device. Exposure to absolute maximum rating conditions for extended periods may affect reliability. Functional operation of the device at any conditions beyond those indicated in the Recommended Operating Conditions section is not implied.

**ESD SENSITIVITY CAUTION**

This integrated circuit can be damaged if ESD protections are not considered carefully. SGMICRO recommends that all integrated circuits be handled with appropriate precautions. Failure to observe proper handling and installation procedures can cause damage. ESD damage can range from subtle performance degradation to complete device failure. Precision integrated circuits may be more susceptible to damage because even small parametric changes could cause the device not to meet the published specifications.

**DISCLAIMER**

SG Micro Corp reserves the right to make any change in circuit design, or specifications without prior notice.

**PIN CONFIGURATIONS**

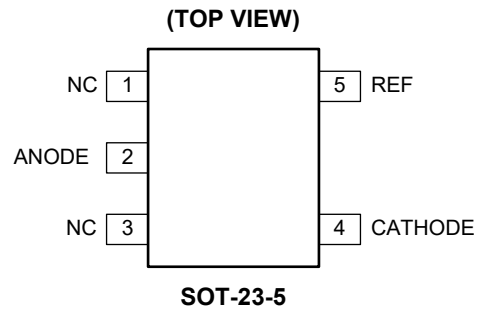
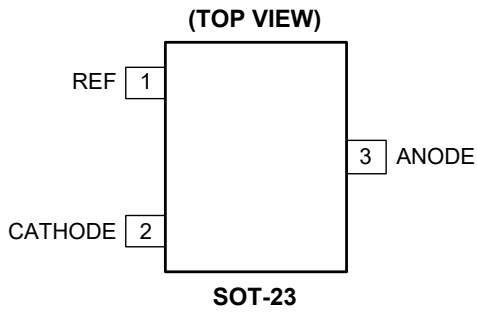
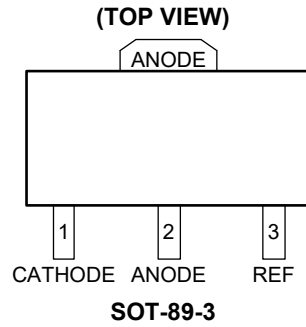

**PIN DESCRIPTION**

| PIN      |        |          | NAME    | TYPE | DESCRIPTION   |
|----------|--------|----------|---------|------|---|
| SOT-89-3 | SOT-23 | SOT-23-5 |         |      |   |
| 1        | 2      | 4        | CATHODE | I/O  | Cathode Pin. Voltage input and shunts current.                |
| 2        | 3      | 2        | ANODE   | O    | Anode Pin. Connect to ground normally.                        |
| 3        | 1      | 5        | REF     | I    | REF Input Pin. Threshold Related to the voltage of ANODE Pin. |
| -        | -      | 1, 3     | NC      | -    | Not Connected.  |

NOTE: I: input, O: output, I/O: input or output.

FUNCTIONAL BLOCK DIAGRAM

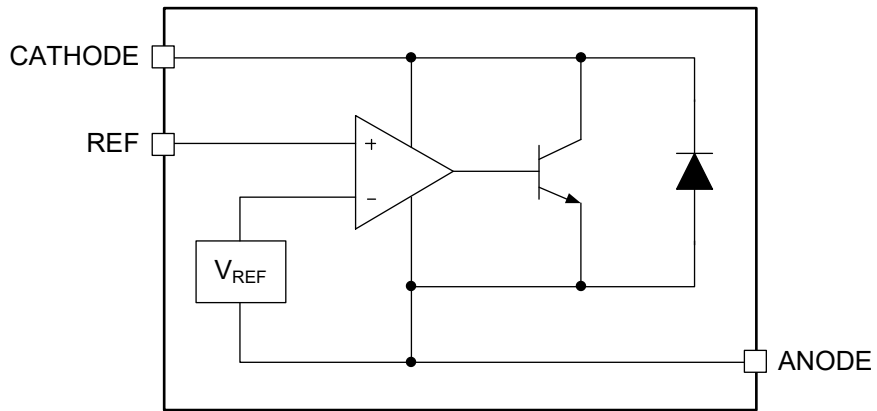

Figure 2. Equivalent Diagram

## ELECTRICAL CHARACTERISTICS

(Over recommended operating conditions,  $T_J = +25^\circ\text{C}$ , unless otherwise noted.)

| PARAMETER   | SYMBOL                         | CONDITIONS   | MIN                                       | TYP   | MAX   | UNITS         |
|---|--------------------------------|--|---|-------|-------|---------------|
| <b>SGM432</b>   |                                |  |   |       |       |               |
| Reference Voltage   | $V_{REF}$                      | $V_{KA} = V_{REF}, I_{KA} = 10\text{mA}$                                     | 2.475                                     | 2.500 | 2.525 | V             |
| Deviation of Reference Input Voltage over Full Temperature Range <sup>(1)</sup> | $V_{I(DEV)}$                   | $V_{KA} = V_{REF}, I_{KA} = 10\text{mA}$                                     |   | 5     | 25    | mV            |
| Ratio of Change in Reference Voltage to the Change in Cathode Voltage           | $\Delta V_{REF}/\Delta V_{KA}$ | $I_{KA} = 10\text{mA}$   | $\Delta V_{KA} = 10\text{V} - V_{REF}$    | -0.5  | -1.0  | mV/V          |
|   |                                |  | $\Delta V_{KA} = 36\text{V} - 10\text{V}$ | 0.1   | 0.5   |               |
| Reference Input Current   | $I_{REF}$                      | $I_{KA} = 10\text{mA}, R_1 = 10\text{k}\Omega, R_2 = \infty$                 |   | 1     | 2     | $\mu\text{A}$ |
| Deviation of Reference Input Current over Full Temperature Range <sup>(1)</sup> | $I_{I(DEV)}$                   | $I_{KA} = 10\text{mA}, R_1 = 10\text{k}\Omega, R_2 = \infty$                 |   | 0.4   | 0.8   | $\mu\text{A}$ |
| Minimum Cathode Current for Regulation  | $I_{MIN}$                      | $V_{KA} = V_{REF}$   |   | 0.4   | 0.7   | mA            |
| Off-State Cathode Current   | $I_{OFF}$                      | $V_{KA} = 36\text{V}, V_{REF} = 0$   |   | 0.1   | 1     | $\mu\text{A}$ |
| Dynamic Impedance <sup>(2)</sup>  | $ Z_{KA} $                     | $V_{KA} = V_{REF}, f \leq 1\text{kHz}, I_{KA} = 1\text{mA to } 100\text{mA}$ |   | 0.1   | 0.5   | $\Omega$      |
| <b>SGM432B</b>  |                                |  |   |       |       |               |
| Reference Voltage   | $V_{REF}$                      | $V_{KA} = V_{REF}, I_{KA} = 10\text{mA}$                                     | 2.488                                     | 2.500 | 2.512 | V             |
| Deviation of Reference Input Voltage over Full Temperature Range <sup>(1)</sup> | $V_{I(DEV)}$                   | $V_{KA} = V_{REF}, I_{KA} = 10\text{mA}$                                     |   | 5     | 25    | mV            |
| Ratio of Change in Reference Voltage to the Change in Cathode Voltage           | $\Delta V_{REF}/\Delta V_{KA}$ | $I_{KA} = 10\text{mA}$   | $\Delta V_{KA} = 10\text{V} - V_{REF}$    | -0.5  | -1.0  | mV/V          |
|   |                                |  | $\Delta V_{KA} = 36\text{V} - 10\text{V}$ | 0.1   | 0.5   |               |
| Reference Input Current   | $I_{REF}$                      | $I_{KA} = 10\text{mA}, R_1 = 10\text{k}\Omega, R_2 = \infty$                 |   | 1     | 2     | $\mu\text{A}$ |
| Deviation of Reference Input Current over Full Temperature Range <sup>(1)</sup> | $I_{I(DEV)}$                   | $I_{KA} = 10\text{mA}, R_1 = 10\text{k}\Omega, R_2 = \infty$                 |   | 0.4   | 0.8   | $\mu\text{A}$ |
| Minimum Cathode Current for Regulation  | $I_{MIN}$                      | $V_{KA} = V_{REF}$   |   | 0.4   | 0.7   | mA            |
| Off-State Cathode Current   | $I_{OFF}$                      | $V_{KA} = 36\text{V}, V_{REF} = 0$   |   | 0.1   | 1     | $\mu\text{A}$ |
| Dynamic Impedance <sup>(2)</sup>  | $ Z_{KA} $                     | $V_{KA} = V_{REF}, f \leq 1\text{kHz}, I_{KA} = 1\text{mA to } 100\text{mA}$ |   | 0.1   | 0.5   | $\Omega$      |

## NOTES:

1.  $V_{I(DEV)}$  and  $I_{I(DEV)}$  refer to the difference between the maximum value and the minimum value obtained within the rated temperature range.  $\alpha_{VREF}$  is defined as:

$$|\alpha_{VREF}| \left( \frac{\text{ppm}}{^\circ\text{C}} \right) = \left| \frac{\left( \frac{V_{I(DEV)}}{V_{REF} \text{ at } 25^\circ\text{C}} \right) \times 10^6}{\Delta T_J} \right|$$

where,

$\Delta T_J$  is the rated operating junction temperature range of the device.

$\alpha_{VREF}$  is the average full-range temperature coefficient of the reference input voltage.

2.  $|Z_{KA}| = \Delta V_{KA} / \Delta I_{KA}$ , when the device is operating with two external resistors, the total dynamic impedance of the circuit is equal to

$$|Z'| = \frac{\Delta V}{\Delta I}, \text{ which is approximately equal to } |Z_{KA}| \left( 1 + \frac{R_1}{R_2} \right).$$

TYPICAL PERFORMANCE CHARACTERISTICS

$T_J = +25^\circ\text{C}$ , unless otherwise noted.

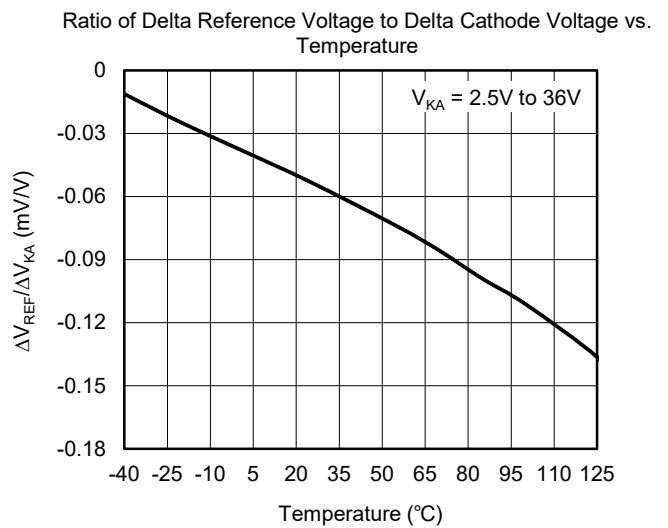
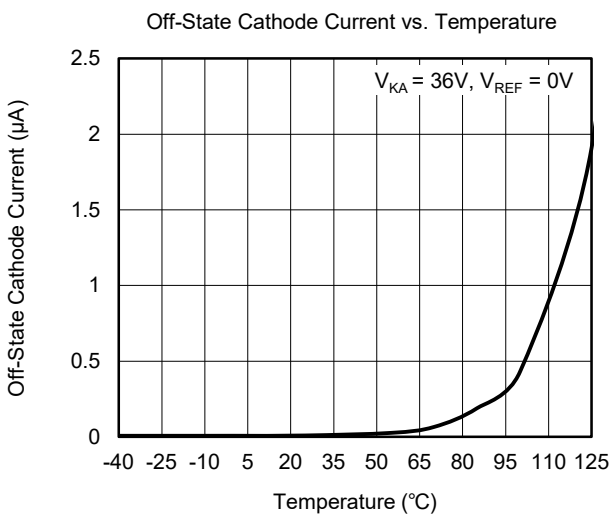
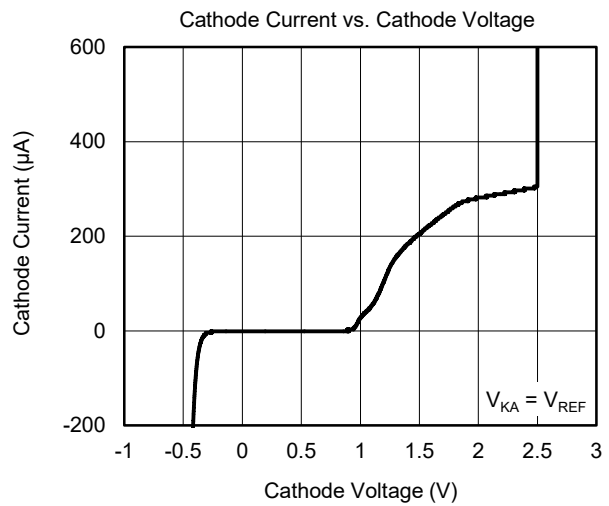
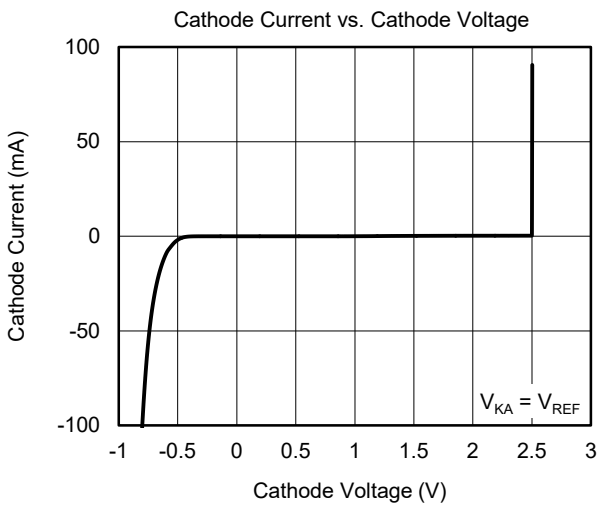
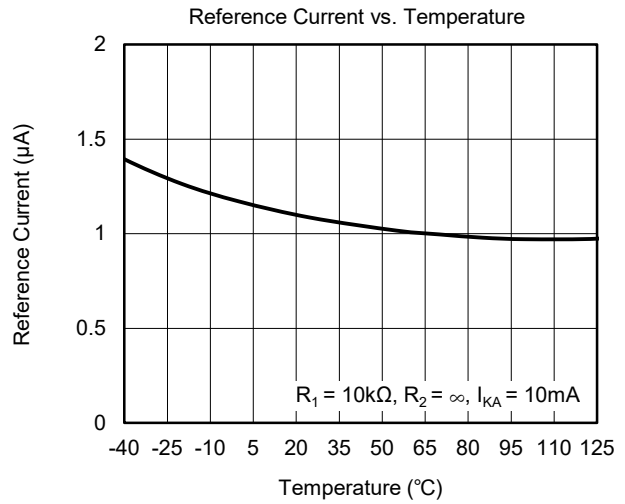
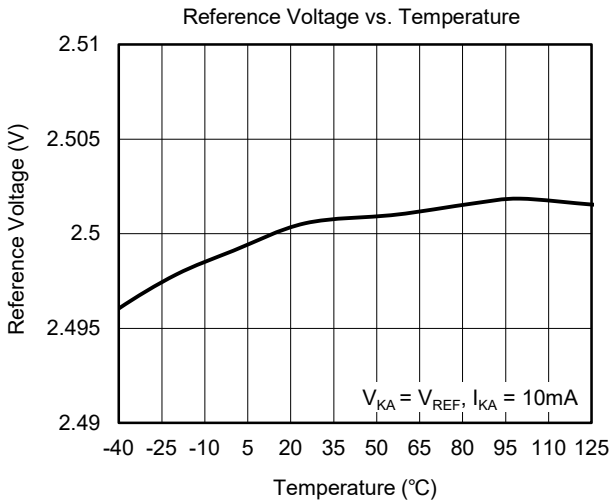

TYPICAL PERFORMANCE CHARACTERISTICS (continued)

T<sub>J</sub> = +25°C, unless otherwise noted.

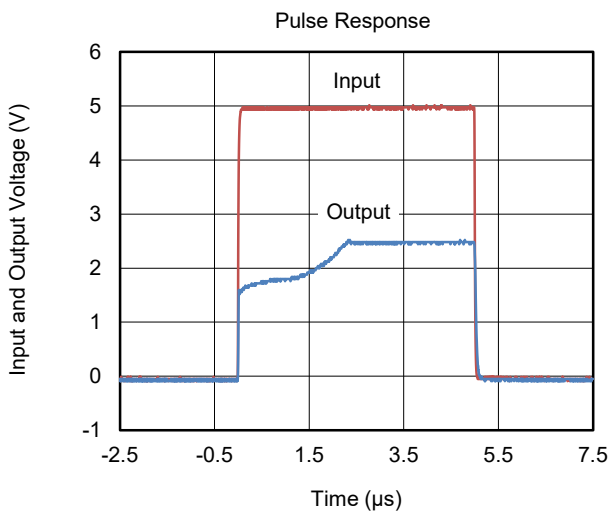
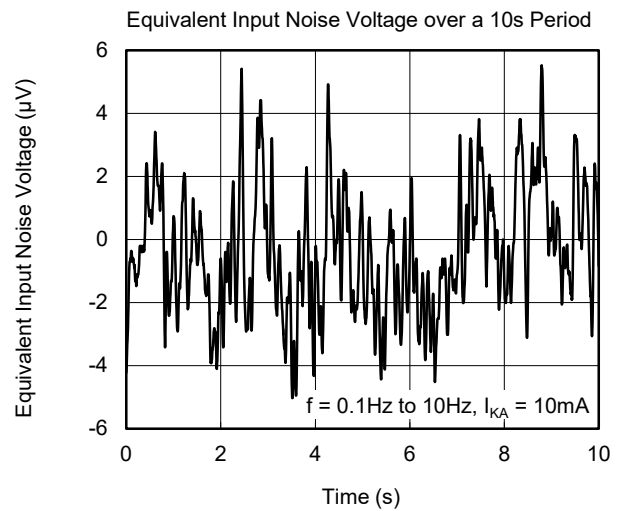
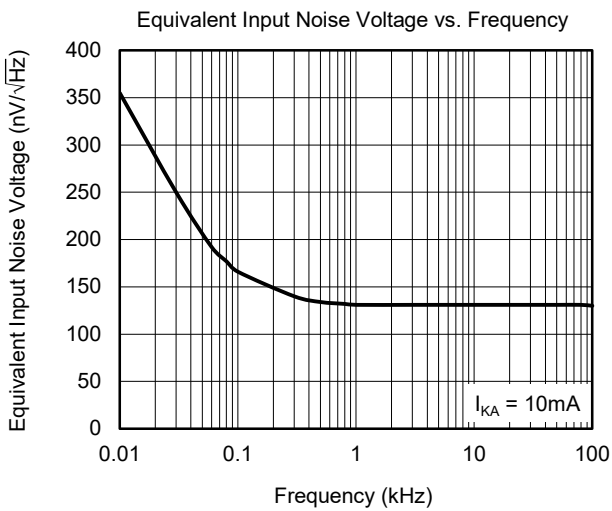
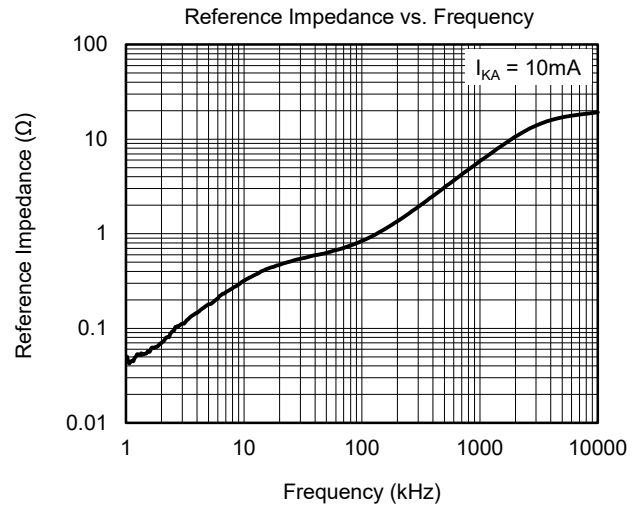
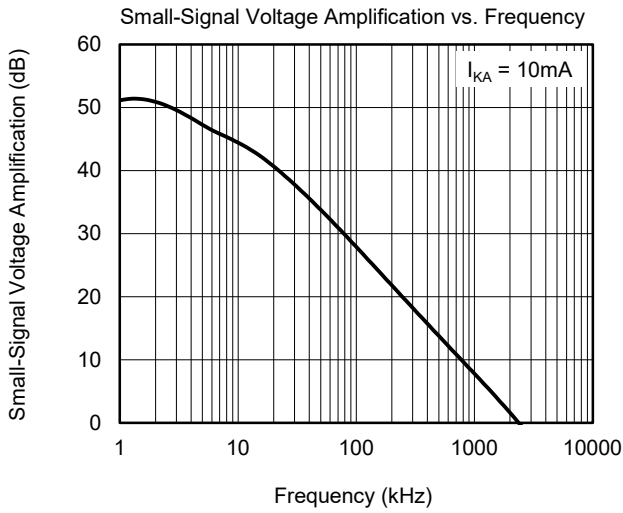

APPLICATION INFORMATION

SGM432x Used as Comparator with Integrated Reference

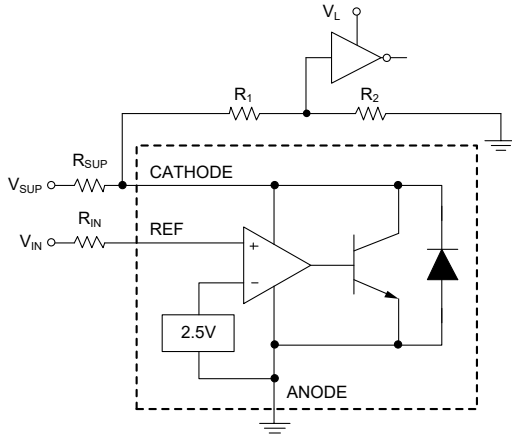

Figure 3. Comparator Application Schematic

Table 1. Design Parameters

| Design Parameter                   | Example Value  |
|------------------------------------|--|
| Input Voltage Range                | 0V to 5V   |
| Input Resistance ( $R_{IN}$ )      | 10k $\Omega$   |
| Supply Voltage Range ( $V_{SUP}$ ) | 5V to 24V  |
| Supply Resistance ( $R_{SUP}$ )    | 1k $\Omega$  |
| Output Voltage Level               | ~ 2V (Logical "Low")<br>~ $V_{SUP}$ (Logical "High") |

As shown in Figure 3, the SGM432x is always used as a comparator with 2.5V integrated reference in application, for this design, the parameters are listed in Table 1. The REF pin voltage is compared with reference inside and is amplified. Also, the SGM432x responds fast if the operation current  $I_{KA}$  is large enough. In Figure 4, it is clear to see that the output response with  $R_{SUP} = 1k\Omega$  is much faster than  $R_{SUP} = 10k\Omega$ . The maximum cathode current of  $I_{MIN}$  is 0.7mA, any cathode current below this value will cause a low response (low open-loop gain) for the application of comparator.

The overdrive voltage is defined as the voltage over the internal reference voltage (2.5V). If the overdrive voltage is not large enough, the output response will be

inaccurate and slow. On the contrary, the larger overdrive voltage provided at the REF pin, the faster the output response will be. Moreover, if the users desire fast response, the overdrive voltage should be larger than 10% of the internal voltage reference.

The input resistance should be less than 10k $\Omega$  in order to minimize the voltage drop between  $V_{IN}$  and  $V_{REF}$ . The readability of the logic output of the comparator should be guaranteed so that it can be received by the next stage. In Figure 4, the  $V_{IL}$  of the comparator logic is 2V, which is sufficient for a 5V supply voltage. However, for the logic stage which is powered by 1.8V or 3.3V, the  $V_{IL}$  is hard to be figured out. To accommodate this, a voltage divider should be taken into account. Due to the Open-Collector (OC) output stage, the  $V_{IH}$  is equal to the voltage of its power supply. When the voltage divider is used to attenuate  $V_{IH}$ , please make sure that the sum of  $R_1$  and  $R_2$  is greater than the resistance  $R_{SUP}$  to the power supply.

However, for this application, an external resistor  $R_{IN}$  is required to provide the  $I_{REF}$  and guarantee the normal operation of the SGM432x. Also, because of the voltage drop across  $R_{IN}$ , so that the gap between  $V_{IN}$  and  $V_{REF}$  is the voltage drop of  $R_{IN}$ . To decrease the error, the selected  $R_{IN}$  should be small enough as the maximum  $I_{REF}$  is 2 $\mu$ A.

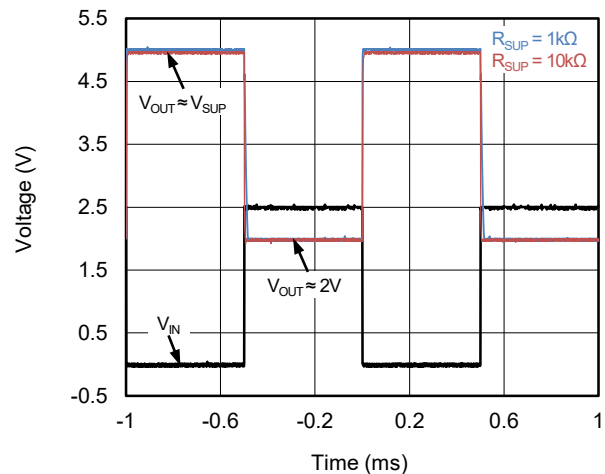

Figure 4. Output Response with Various Cathode Current



APPLICATION INFORMATION (continued)

Shunt Regulator/Reference

Total Accuracy

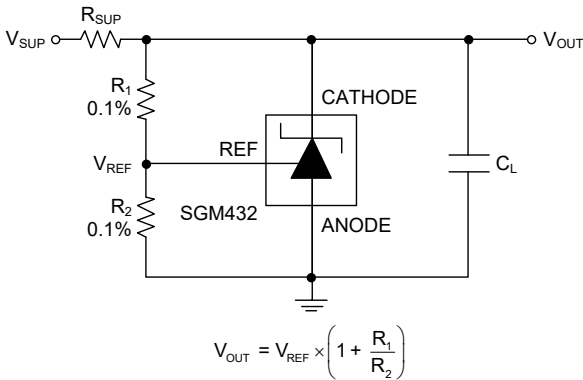

Figure 5. Shunt Regulator Schematic

As shown in Figure 5, for this design, the input parameters are listed in Table 2.

Table 2. Design Parameters

| Design Parameter   | Example Value |
|--|---------------|
| Supply Voltage   | 40V           |
| Cathode Current (I <sub>KA</sub> )   | 5mA           |
| Output Voltage Range   | 2.5V to 36V   |
| Load Capacitance   | 100nF         |
| Feedback Resistor Values and Accuracy (R <sub>1</sub> and R <sub>2</sub> ) | 10kΩ (0.1%)   |

Programming Output Voltage

The output/cathode voltage of the SGM432x is programmed by resistor R<sub>1</sub> and R<sub>2</sub>. The following equation shows the relationship between V<sub>REF</sub> and V<sub>OUT</sub>. In accurate applications, the error caused by I<sub>REF</sub> should also be taken into account:

$$V_{OUT} = V_{REF} \left( 1 + \frac{R_1}{R_2} \right) + I_{REF} \times R_1$$

And the users need to ensure that the SGM432x is fully biased, so that this error can be decreased significantly by the enough open-loop gain. This can be qualified by satisfying the minimum cathode current I<sub>MIN</sub> in Electrical Characteristics.

When the output voltage is set higher than unity gain (2.5V), the behavior of the SGM432x will be influenced by the following possible errors:

- ◆ The accuracy of both R<sub>1</sub> and R<sub>2</sub>.
- ◆ The internal reference voltage will be changed by the temperature.
- ◆ ΔV<sub>REF</sub>/ΔV<sub>KA</sub>: The change of internal reference voltage will affect the output voltage.
- ◆ |Z<sub>KA</sub>|: This impedance will be affected by the cathode current.

The above possible errors are the worst cases for the operation of the SGM432x.

Stability

For traditional 431 devices, the reference output stability is affected by output decoupling capacitor which must be selected in a limited range in order to keep 431 devices stable in applications. However, the SGM432x is different from the others. The SGM432x uses a special design to greatly improve output stability when it drives capacitive load. From the curve of the Cathode Current vs. Load Capacitance in Figure 6, the output of the SGM432x is stable in a wider range of capacitive load. If the SGM432x is used as a linear regulator, a bigger decoupling capacitor can be used to improve regulator's load transient or reduce the noise of power supply. If the SGM432x is used to replace the others, the SGM432x will be stable and there is no need to change the output decoupling capacitor in the original design.

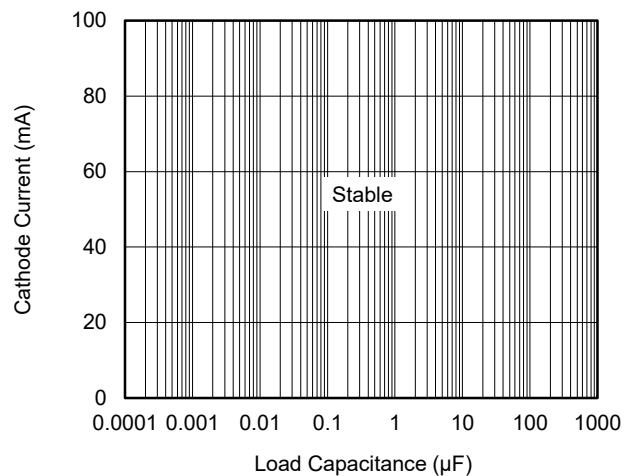

Figure 6. Cathode Current vs. Load Capacitance

APPLICATION INFORMATION (continued)

Start-Up Time

As shown in Figure 7, the SGM432x is suitable for many clamp applications with the fast response.

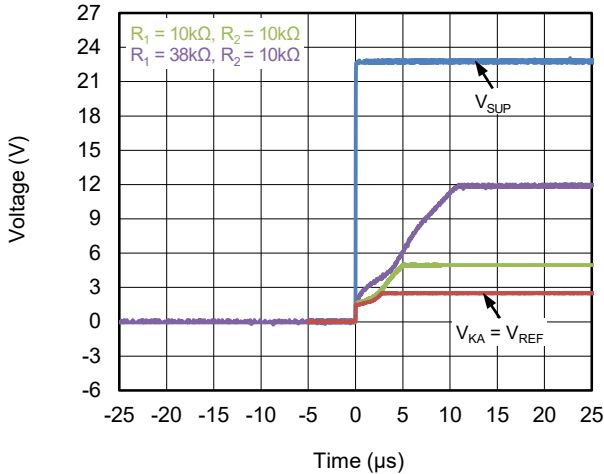

Figure 7. SGM432x Start-Up Response

Power Supply Recommendations

When the SGM432x is used as a shunt regulator, it is necessary to use a bypass capacitor on the CATHODE pin.

Limiting the current of the power supply is necessary for the SGM432x to operate within the maximum cathode current. Also, the current of the REF pin should be limited as well.

When the device shunts high current, adjusting the width and length of traces on the CATHODE pin and ANODE pin is necessary in the PCB board to have a proper density of current.

Layout

Please make sure that the bypass capacitor is close enough to the part. The width of trace on the PCB should be fit for its amount of current flowing. For the SGM432x, these currents will not be large.

REVISION HISTORY

NOTE: Page numbers for previous revisions may differ from page numbers in the current version.

| SEPTEMBER 2024 – REV.A.3 to REV.A.4                  | Page     |
|--|----------|
| Updated Application Information section.....         | 8, 9, 10 |
| NOVEMBER 2020 – REV.A.2 to REV.A.3                   | Page     |
| Updated Package/Ordering Information section.....    | 2        |
| SEPTEMBER 2020 – REV.A.1 to REV.A.2                  | Page     |
| Updated Application Information section.....         | 10       |
| AUGUST 2020 – REV.A to REV.A.1                       | Page     |
| Updated Electrical Characteristics section.....      | 4        |
| Updated Application Information section.....         | 11       |
| Changes from Original (MAY 2020) to REV.A            | Page     |
| Changed from product preview to production data..... | All      |

PACKAGE OUTLINE DIMENSIONS

SOT-89-3

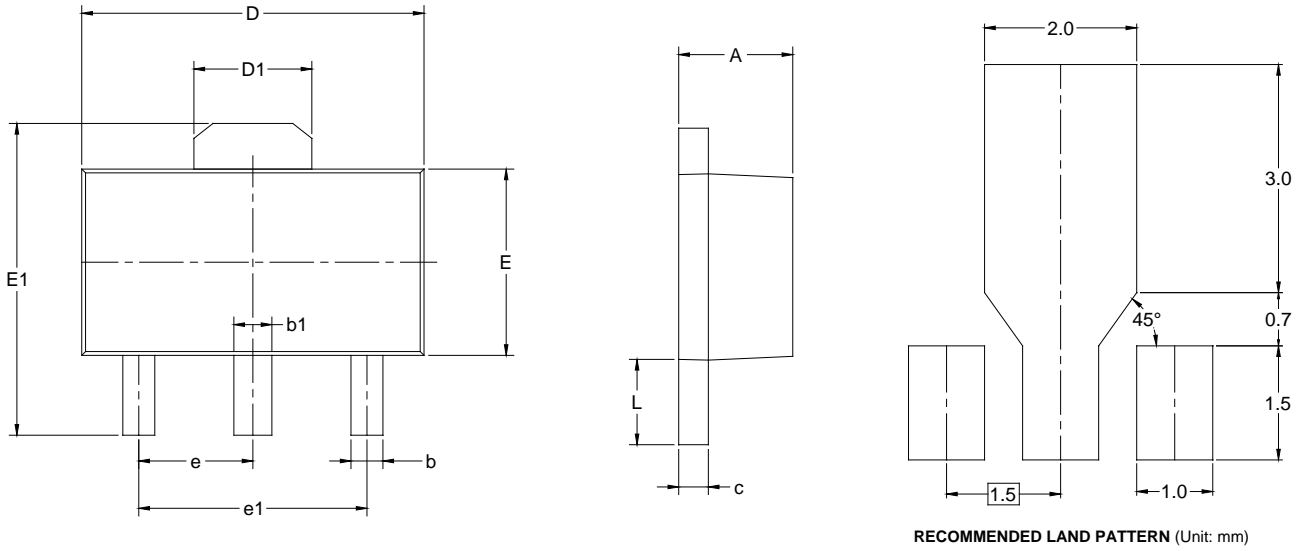

RECOMMENDED LAND PATTERN (Unit: mm)

| Symbol | Dimensions<br>In Millimeters |       | Dimensions<br>In Inches |       |
|--------|------------------------------|-------|-------------------------|-------|
|        | MIN                          | MAX   | MIN                     | MAX   |
| A      | 1.400                        | 1.600 | 0.055                   | 0.063 |
| b      | 0.320                        | 0.520 | 0.013                   | 0.020 |
| b1     | 0.400                        | 0.580 | 0.016                   | 0.023 |
| c      | 0.350                        | 0.440 | 0.014                   | 0.017 |
| D      | 4.400                        | 4.600 | 0.173                   | 0.181 |
| D1     | 1.550 REF                    |       | 0.061 REF               |       |
| E      | 2.300                        | 2.600 | 0.091                   | 0.102 |
| E1     | 3.940                        | 4.250 | 0.155                   | 0.167 |
| e      | 1.500 TYP                    |       | 0.060 TYP               |       |
| e1     | 3.000 TYP                    |       | 0.118 TYP               |       |
| L      | 0.900                        | 1.200 | 0.035                   | 0.047 |

NOTES:

1. Body dimensions do not include mode flash or protrusion.
2. This drawing is subject to change without notice.

PACKAGE OUTLINE DIMENSIONS

SOT-23

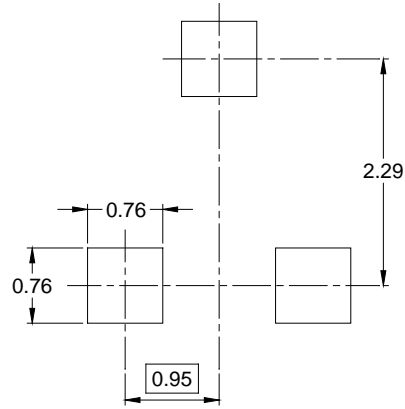
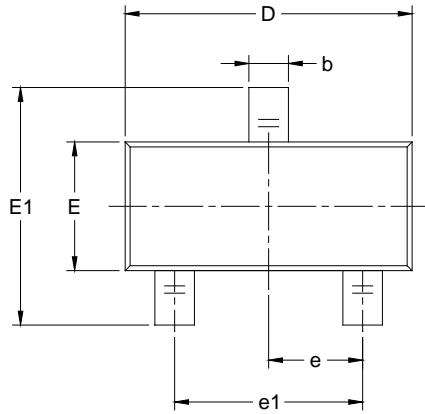

RECOMMENDED LAND PATTERN (Unit: mm)

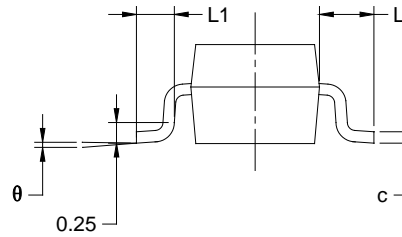
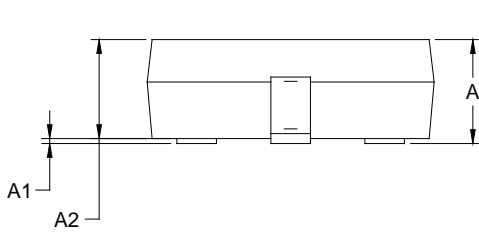

| Symbol   | Dimensions<br>In Millimeters |      | Dimensions<br>In Inches |       |
|----------|------------------------------|------|-------------------------|-------|
|          | MIN                          | MAX  | MIN                     | MAX   |
| A        | 0.89                         | 1.12 | 0.035                   | 0.044 |
| A1       | 0.01                         | 0.10 | 0.000                   | 0.004 |
| A2       | 0.88                         | 1.02 | 0.035                   | 0.040 |
| b        | 0.30                         | 0.50 | 0.012                   | 0.020 |
| c        | 0.08                         | 0.20 | 0.003                   | 0.008 |
| D        | 2.80                         | 3.04 | 0.110                   | 0.120 |
| E        | 1.20                         | 1.40 | 0.047                   | 0.055 |
| E1       | 2.10                         | 2.64 | 0.083                   | 0.104 |
| e        | 0.95 BSC                     |      | 0.037 BSC               |       |
| e1       | 1.90 BSC                     |      | 0.075 BSC               |       |
| L        | 0.54 REF                     |      | 0.021 REF               |       |
| L1       | 0.40                         | 0.60 | 0.016                   | 0.024 |
| $\theta$ | 0°                           | 8°   | 0°                      | 8°    |

NOTES:

1. Body dimensions do not include mode flash or protrusion.
2. This drawing is subject to change without notice.

PACKAGE OUTLINE DIMENSIONS

SOT-23-5

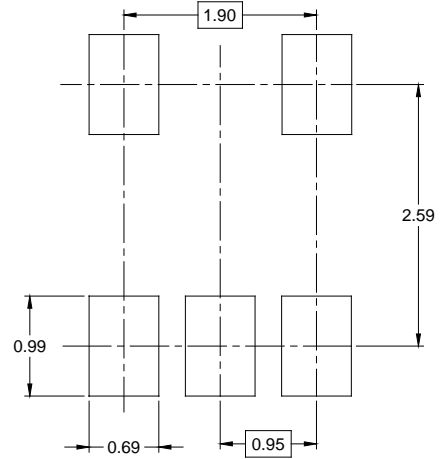
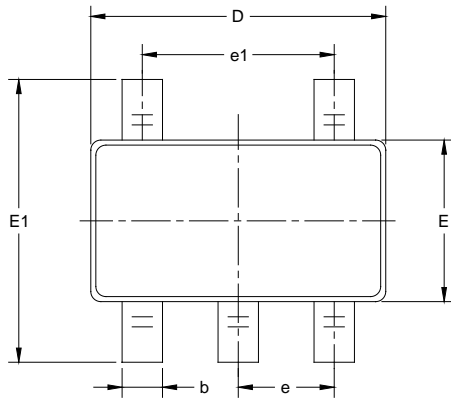

RECOMMENDED LAND PATTERN (Unit: mm)

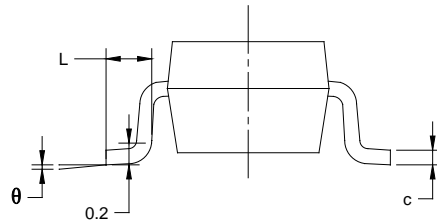
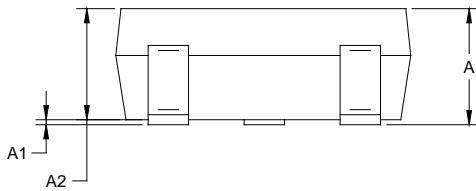

| Symbol   | Dimensions<br>In Millimeters |       | Dimensions<br>In Inches |       |
|----------|------------------------------|-------|-------------------------|-------|
|          | MIN                          | MAX   | MIN                     | MAX   |
| A        | 1.050                        | 1.250 | 0.041                   | 0.049 |
| A1       | 0.000                        | 0.100 | 0.000                   | 0.004 |
| A2       | 1.050                        | 1.150 | 0.041                   | 0.045 |
| b        | 0.300                        | 0.500 | 0.012                   | 0.020 |
| c        | 0.100                        | 0.200 | 0.004                   | 0.008 |
| D        | 2.820                        | 3.020 | 0.111                   | 0.119 |
| E        | 1.500                        | 1.700 | 0.059                   | 0.067 |
| E1       | 2.650                        | 2.950 | 0.104                   | 0.116 |
| e        | 0.950 BSC                    |       | 0.037 BSC               |       |
| e1       | 1.900 BSC                    |       | 0.075 BSC               |       |
| L        | 0.300                        | 0.600 | 0.012                   | 0.024 |
| $\theta$ | 0°                           | 8°    | 0°                      | 8°    |

NOTES:

1. Body dimensions do not include mode flash or protrusion.
2. This drawing is subject to change without notice.

# PACKAGE INFORMATION

## TAPE AND REEL INFORMATION

### REEL DIMENSIONS



### TAPE DIMENSIONS



NOTE: The picture is only for reference. Please make the object as the standard.

### KEY PARAMETER LIST OF TAPE AND REEL

| Package Type | Reel Diameter | Reel Width W1 (mm) | A0 (mm) | B0 (mm) | K0 (mm) | P0 (mm) | P1 (mm) | P2 (mm) | W (mm) | Pin1 Quadrant |
|--------------|---------------|--------------------|---------|---------|---------|---------|---------|---------|--------|---------------|
| SOT-89-3     | 7"            | 13.2               | 4.85    | 4.45    | 1.85    | 4.0     | 8.0     | 2.0     | 12.0   | Q3            |
| SOT-23       | 7"            | 9.5                | 3.15    | 2.77    | 1.22    | 4.0     | 4.0     | 2.0     | 8.0    | Q3            |
| SOT-23-5     | 7"            | 9.5                | 3.20    | 3.20    | 1.40    | 4.0     | 4.0     | 2.0     | 8.0    | Q3            |

DD0001

# PACKAGE INFORMATION

## CARTON BOX DIMENSIONS



NOTE: The picture is only for reference. Please make the object as the standard.

## KEY PARAMETER LIST OF CARTON BOX

| Reel Type   | Length (mm) | Width (mm) | Height (mm) | Pizza/Carton |
|-------------|-------------|------------|-------------|--------------|
| 7" (Option) | 368         | 227        | 224         | 8            |
| 7"          | 442         | 410        | 224         | 18           |

DD0002