



SGM3753

38V High Efficiency, Boost White LED Driver with PWM Dimming Control

GENERAL DESCRIPTION

The SGM3753 is an asynchronous Boost WLED driver with high efficiency, low EMI and high output voltage. The Boost converter integrates a 40V, 1.5A internal FET which operates at 600kHz switching frequency. Its strong driving ability can drive single or multiple parallel LED strings, which can be used as LED driver for smart phone and tablet backlight.

The default LED current can be programmed by the external current-sense resistor R_{SET} . By varying the duty cycle of the PWM signal applied to the CTRL pin, the internal reference voltage is adjusted, which ultimately adjusts the LED sink current. With full PWM duty cycle, the internal reference voltage V_{REF} is 200mV (TYP). The SGM3753 is essentially a driver that adopts analog dimming control, and it will not produce audible noise on the output capacitor. The SGM3753 integrates ringing cancellation, and it can effectively reduce EMI noise in DCM mode. The SGM3753 provides excellent line regulation and load regulation, as well as excellent load transient response. The SGM3753 also features various protection functions such as open LED protection, OCP protection and thermal shutdown protection.

The SGM3753 is available in a Green TDFN-2×2-6L package. It operates over an ambient temperature range of -40°C to +85°C.

FEATURES

- **Input Voltage Range: 2.7V to 5.5V**
- **1:250 Stable Luminance Dimming**
- **Low EMI by Conducting Ringing Cancelling**
- **Improved PSRR for Waveless Lighting**
- **Up to 90% Efficiency**
- **Switching Frequency: 600kHz**
- **Integrated 40V/1.5A Switch**
- **Feedback Voltage: 200mV**
- **PWM Dimming Control**
- **38V Open LED Protection for 10 LEDs in Series**
- **Automatic Soft-Start for Reduced Inrush Current**
- **Under-Voltage Lockout Protection**
- **Thermal Shutdown**
- **-40°C to +85°C Operating Temperature Range**
- **Available in a Green TDFN-2×2-6L Package**

APPLICATIONS

Portable Devices Backlight

Small and Medium Size White LCD Display Backlight

PACKAGE/ORDERING INFORMATION

MODEL	PACKAGE DESCRIPTION	SPECIFIED TEMPERATURE RANGE	ORDERING NUMBER	PACKAGE MARKING	PACKING OPTION
SGM3753	TDFN-2x2-6L	-40°C to +85°C	SGM3753YTDI6G/TR	3753 XXXX	Tape and Reel, 3000

MARKING INFORMATION

NOTE: XXXX = Date Code.

XXXX

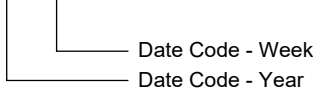

Green (RoHS & HSF): SG Micro Corp defines "Green" to mean Pb-Free (RoHS compatible) and free of halogen substances. If you have additional comments or questions, please contact your SGMICRO representative directly.

ABSOLUTE MAXIMUM RATINGS

- Voltage on VIN, CTRL, FB..... -0.3V to 6V
- Package Thermal Resistance
- TDFN-2x2-6L, θ_{JA} 120°C/W
- Voltage on SW..... -0.3V to 40V
- Junction Temperature..... +150°C
- Storage Temperature Range..... -65°C to +150°C
- Lead Temperature (Soldering, 10s)..... +260°C
- ESD Susceptibility
- HBM..... 2000V
- MM..... 200V
- CDM..... 1000V

RECOMMENDED OPERATING CONDITIONS

- Input Voltage Range..... 2.7V to 5.5V
- Output Voltage Range..... V_{IN} to 38V
- Inductor..... 10 μ H to 22 μ H
- Input Capacitor..... 1 μ F (MIN)
- Output Capacitor..... 1 μ F to 10 μ F
- Operating Temperature Range..... -40°C to +85°C

OVERSTRESS CAUTION

Stresses beyond those listed in Absolute Maximum Ratings may cause permanent damage to the device. Exposure to absolute maximum rating conditions for extended periods may affect reliability. Functional operation of the device at any conditions beyond those indicated in the Recommended Operating Conditions section is not implied.

ESD SENSITIVITY CAUTION

This integrated circuit can be damaged if ESD protections are not considered carefully. SGMICRO recommends that all integrated circuits be handled with appropriate precautions. Failure to observe proper handling and installation procedures can cause damage. ESD damage can range from subtle performance degradation to complete device failure. Precision integrated circuits may be more susceptible to damage because even small parametric changes could cause the device not to meet the published specifications.

DISCLAIMER

SG Micro Corp reserves the right to make any change in circuit design, or specifications without prior notice.

PIN CONFIGURATION

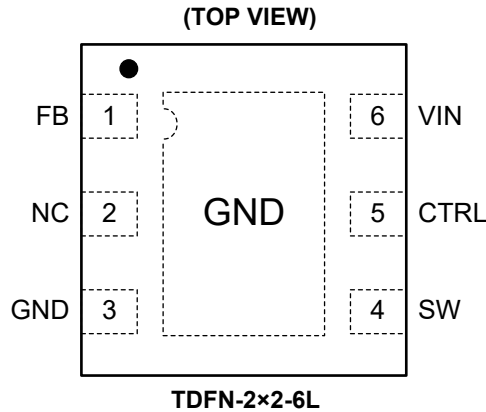

PIN DESCRIPTION

PIN	NAME	I/O	FUNCTION
1	FB	I	Feedback Input for Current. Connect the sense resistor between FB and GND.
2	NC	-	No Connection.
3	GND	O	Ground.
4	SW	I	The Switch Pin of the Device. It is connected to the drain of the internal N-channel power FET.
5	CTRL	I	PWM Dimming Input.
6	VIN	I	Input Supply Pin.

NOTE: I: input, O: output.

TYPICAL APPLICATION

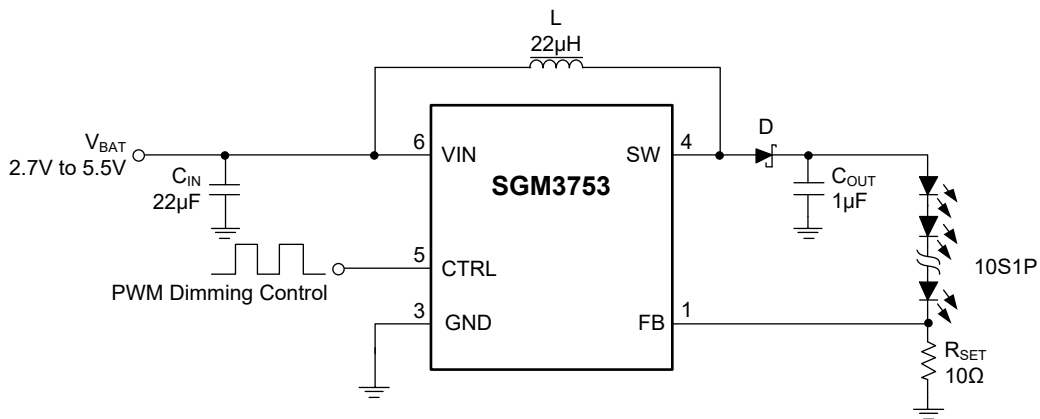

Figure 1. Typical Application

ELECTRICAL CHARACTERISTICS(V_{IN} = 3.6V, CTRL = V_{IN}, C_{IN} = 22μF, Full = -40°C to +85°C, typical values are at T_A = +25°C, unless otherwise noted.)

PARAMETER	SYMBOL	CONDITIONS	TEMP	MIN	TYP	MAX	UNIT
Power Supply							
Input Voltage Range	V _{IN}		Full	2.7		5.5	V
Under-Voltage Lockout Threshold	UVLO	V _{IN} falling	+25°C		2.2		V
		V _{IN} rising	+25°C		2.3	2.5	
UVLO Hysteresis	V _{HYS}		+25°C		100		mV
Operating Quiescent Current into V _{IN}	I _Q	V _{FB} = 400mV, no switching	+25°C		0.2	0.35	mA
Shutdown Current	I _{SD}	CTRL = GND	+25°C			1	μA
Boost Converter							
Voltage Feedback Regulation Voltage	V _{REF}	PWM duty cycle 100%	+25°C	193.5	200	205.3	mV
		PWM duty cycle 10%	+25°C	18.5	20.3	22.5	mV
		PWM duty cycle 1%	+25°C	1.65	2.5	3.25	mV
		PWM duty cycle 0.2%	+25°C		0.92		mV
FB Pin Bias Current	I _{FB}	V _{FB} = 200mV	Full		0.001	0.3	μA
V _{REF} Filter Time Constant	t _{REF}		+25°C		0.1		ms
N-Channel MOSFET On-Resistance	R _{DS(ON)}		+25°C		0.5	0.8	Ω
Switching Frequency	f _{SW}		Full	480	600	750	kHz
Switching MOSFET Current Limit	I _{LIM}		+25°C	1.15	1.5	1.85	A
Output Voltage Over-Voltage Threshold	V _{OVP_SW}		Full	36	38	39.5	V
Control							
CTRL Logic High Voltage	V _H		Full	1.5			V
CTRL Logic Low Voltage	V _L		Full			0.4	V
CTRL Pin Internal Pull-Down Resistor	R _{PD}		+25°C		600		kΩ
CTRL Logic Low Time to Shutdown	t _{SD}	CTRL high to low	+25°C	2.5			ms
PWM Dimming Frequency Range	DFR		+25°C	10		100	kHz
Minimum PWM On-Time			+25°C	40			ns
Stable Dimming Range	DR		+25°C	0.2		100	%
Thermal Shutdown							
Thermal Shutdown Threshold	T _{SHUTDOWN}				160		°C
Thermal Shutdown Hysteresis	T _{HYS}				20		°C

RECOMMENDED COMPONENTS OF TEST CIRCUITS

	COMPONENT		COMPONENT
INDUCTOR	22 μ H/CD75NP-220KC	CAPACITOR	1 μ F/C2012X7R1H105KT
DIODE	MBR0540		22 μ F/C2012X7R1H226KT

TYPICAL PERFORMANCE CHARACTERISTICS

T_A = +25°C, L = 22 μ H, C_{IN} = 22 μ F, C_{OUT} = 1 μ F, unless otherwise noted.

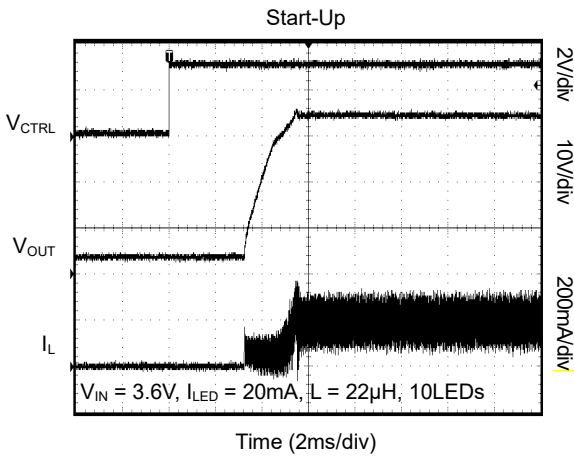
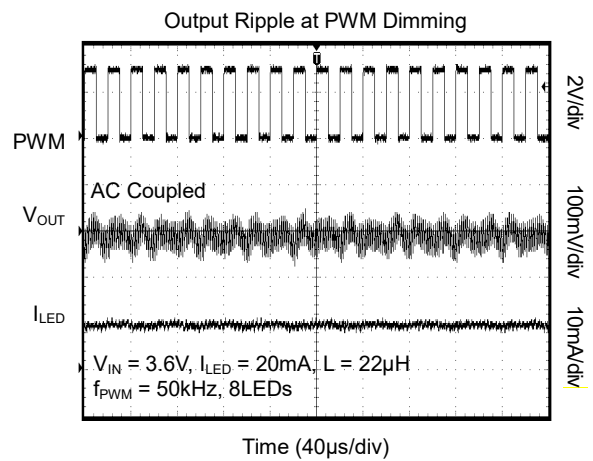
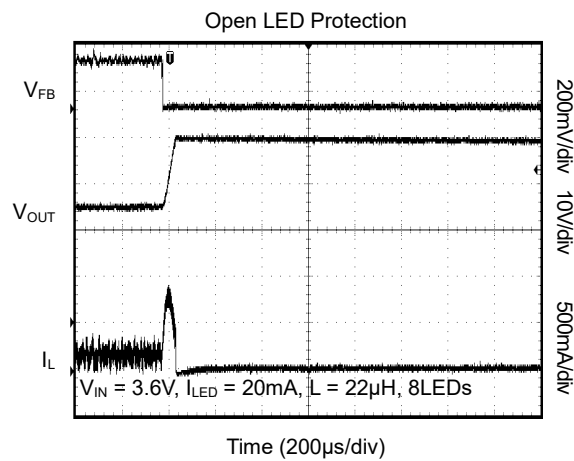

TYPICAL PERFORMANCE CHARACTERISTICS (continued)

T_A = +25°C, L = 22µH, C_{IN} = 22µF, C_{OUT} = 1µF, unless otherwise noted.

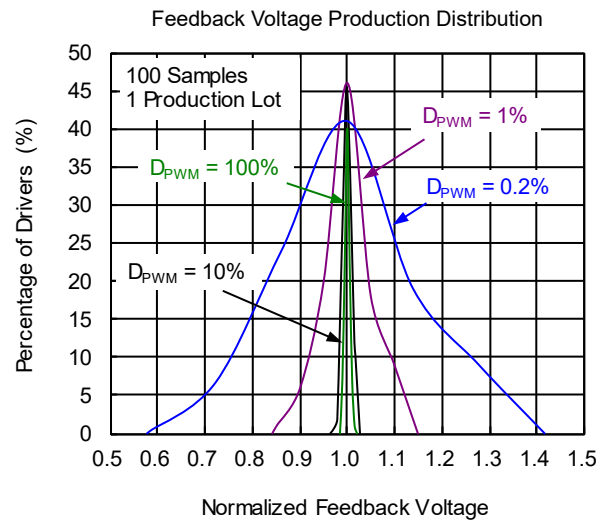
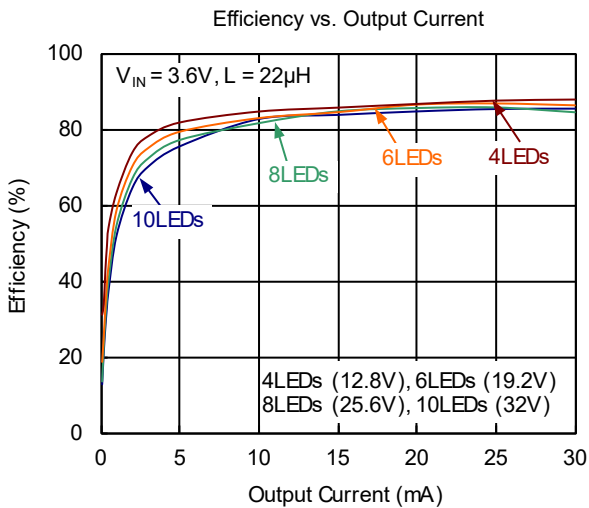
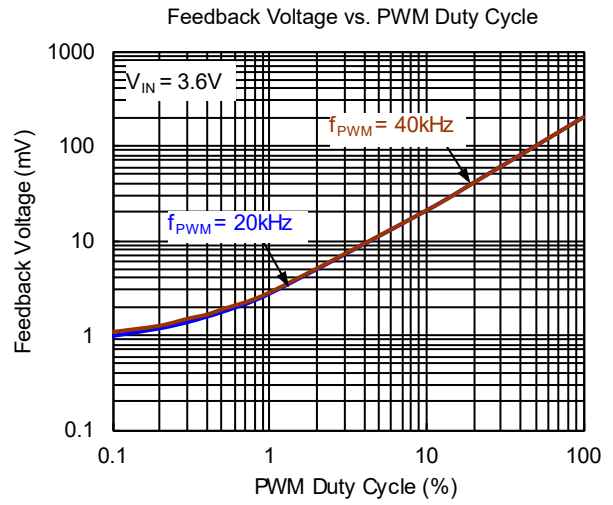
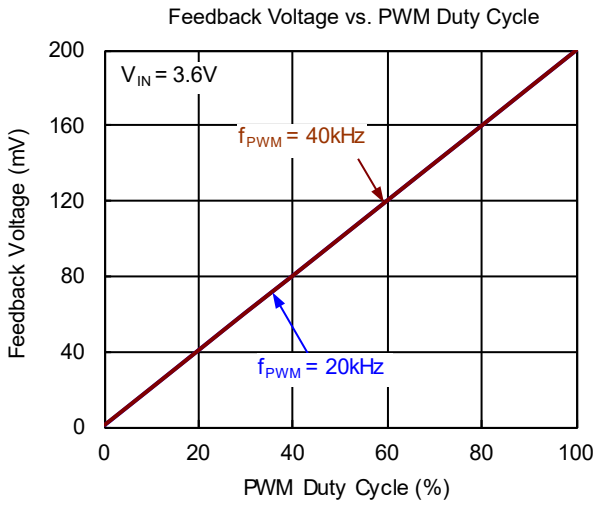

FUNCTIONAL BLOCK DIAGRAM

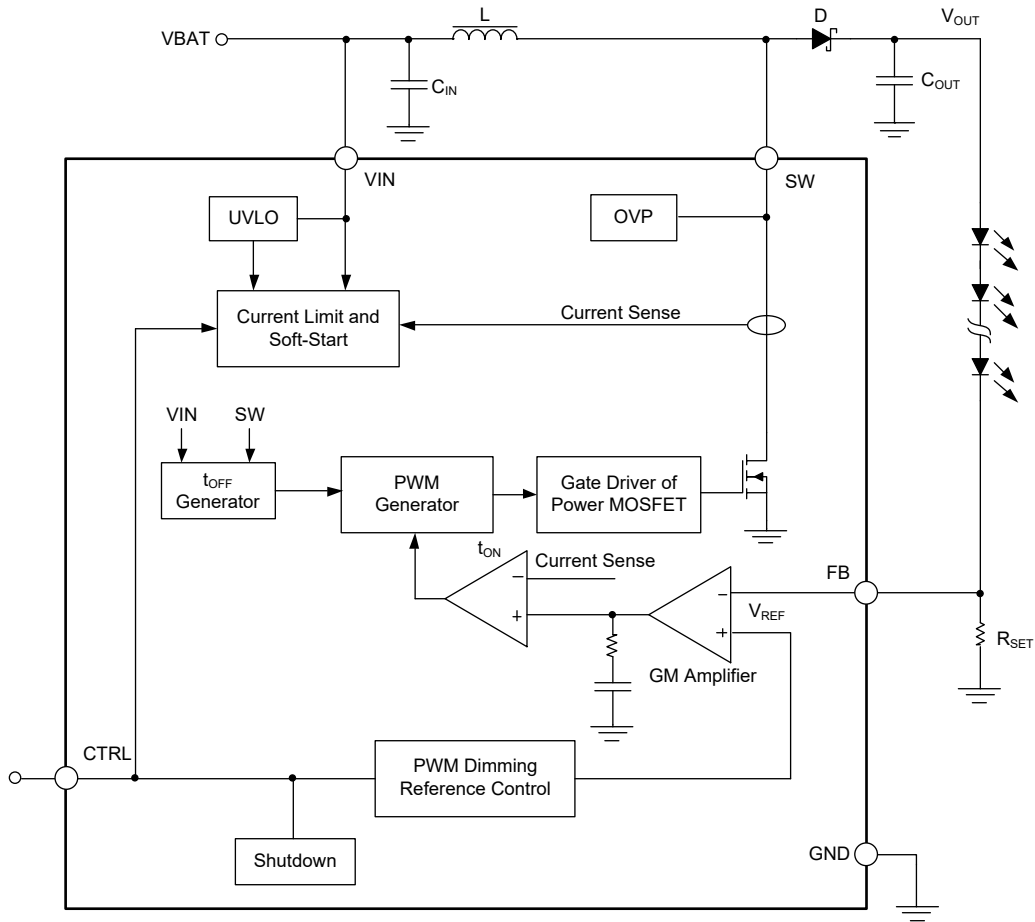

Figure 2. Functional Block Diagram

DETAILED DESCRIPTION

The SGM3753 is an asynchronous Boost converter that operates at 600kHz switching frequency and integrates a power FET with peak current limit of 1.5A. The maximum output voltage can reach 38V. The device is capable of driving LEDs from 1 series to 10 series and the input voltage range is 2.7V to 5.5V. The strong driving capability of the device can drive single or multiple parallel LED strings, which can be used as LED driver for smart phone and tablet backlight.

The SGM3753 operates with peak current control, and the internal compensation circuit greatly reduces the complexity of the design. The loop design can be completed with only one external sampling resistor R_{SET} . Peak current mode controls the on time of the switching FET by comparing the error signal of the internal GM amplifier with the inductance current signal.

Through the duty cycle of the PWM signal added to the CTRL pin, the SGM3753 can set the reference voltage V_{REF} . When the duty cycle is 100%/10%/1%, the typical values of V_{REF} are 200mV/20.3mV/2.5mV respectively, and the supported PWM signal has a wide frequency range from 10kHz to 100kHz.

The SGM3753 also has excellent line regulation and load regulation, as well as excellent load transient response performance. It also has complete protection functions, including open LED protection, OCP protection and thermal shutdown protection. At the same time, the output current can be programmed through the resistor R_{SET} connected to the FB pin.

Soft Start-Up

SGM3753 integrates the soft start-up function to ensure that the output voltage of Boost converter rises slowly by limiting the output voltage of GM amplifier during start-up. This method effectively avoids the surge current. After the start-up is completed, the device switches to the internal reference voltage for closed-loop control.

Open LED Protection

Open LED protection feature shuts off the IC in case of LED or R_{SET} disconnection, which prevents damage to the device. The SGM3753 monitors the voltage of SW pin in each switching cycle. When V_{SW} exceeds V_{OVP} threshold for 8 consecutive cycles, the device turns the switch FET off, and shuts down the IC. The device remains in shutdown until the CTRL pin is toggled to

logic high. This function can effectively prevent the device from being damaged when the output voltage exceeds V_{OVP} threshold.

Shutdown

When the CTRL pin remains low voltage for more than 2.5ms, the SGM3753 enters shutdown mode. In shutdown mode, the internal switch FET stops switching, and the device maintains in a low loss condition. At the same time, the minimum forward voltage of the LED array should be kept higher than the maximum input voltage. Otherwise a DC current path is resulted from the inductor and Schottky diode to the LED array.

Current Program

The FB pin voltage V_{FB} depends on the internal reference voltage V_{REF} . At full PWM duty cycle, the typical value of V_{REF} is 200mV. The external programming of LED current can be realized by using the current-sense resistor connected in series with the LED. The R_{SET} resistor value is given by Equation 1:

$$I_{LED} = \frac{V_{FB}}{R_{SET}} \quad (1)$$

where

I_{LED} = sum of LED string(s) current

V_{FB} = FB pin regulation voltage

R_{SET} = current sense resistor.

The FB voltage accuracy and current sense resistor accuracy determines the output current accuracy.

LED Brightness Dimming

The PWM signal applied to the CTRL pin controls the LED current. For PWM dimming signal, the device required PWM frequency range is 10kHz to 100kHz, which can obtain accurate reference voltage and small LED current ripple. The LED brightness dimming can be realized by changing PWM duty cycle. The relationship between duty cycle and FB regulation voltage is calculated by Equation 2:

$$V_{FB} = \text{Duty} \times 200\text{mV} + 0.75\text{mV} \quad (2)$$

where

Duty = duty cycle of the PWM signal

200mV = internal reference voltage

0.75mV = most appreciate maximum from production statistics

DETAILED DESCRIPTION (continued)

The LED brightness is easily adjusted by controlling the duty cycle of the PWM signal applied to CTRL pin. The recommended minimum PWM duty cycle is 0.1% for no blind dimming.

As shown in Figure 3, the SGM3753 adjusts the 200mV reference voltage based on PWM duty cycle of the CTRL pin. The PWM reference voltage is then filtered by the internal RC filter. The RC filter output is then fed to the non-inverting input of the error amplifier. The advantage is that the value of the reference voltage V_{REF} only depends the duty cycle of the PWM signal and does not depend on the amplitude. Under this working principle, although the PWM signal is used for dimming, its essence is an analog dimming. The PWM signal is only used to modulate the reference voltage V_{REF} , which can avoid the occurrence of audible noise.

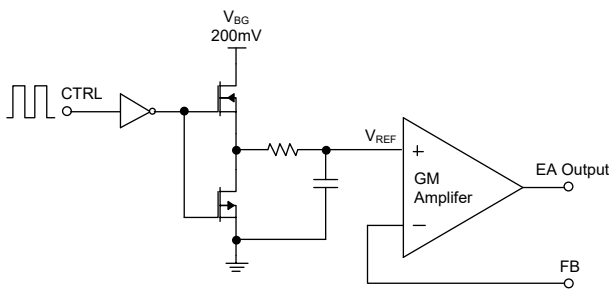

Figure 3. FB Voltage Adjustment via PWM Signal

However, it should be noted that since the reference voltage V_{REF} is obtained by the charge and discharge of the RC low-pass filter, the V_{REF} has a ripple voltage with the same frequency as the PWM signal, which will significantly increase the LED ripple current. With the increase of PWM signal frequency, the ripple voltage of V_{REF} decreases, and the LED ripple current decreases.

Under-Voltage Lockout

Under-voltage lockout prevents the device from operating at input voltage below 2.2V (TYP). When V_{IN} falls below 2.2V, the device enters shutdown mode and the internal switch FET is turned off. If V_{IN} reaches 2.3V (TYP), the IC will resume operation.

Thermal Shutdown

When the junction temperature of the IC exceeds 160°C (TYP), the internal thermal shutdown is triggered and the device enters the shutdown state. When the junction temperature is dropped by 20°C (TYP), the device will restart and resume operation.

Operation with CTRL

The CTRL pin is an enable control pin with logic high voltage of 1.5V and logic low voltage of 0.4V. When the control voltage of CTRL pin is higher than 1.5V and the input voltage is higher than the UVLO threshold, the device starts up. When the control voltage of CTRL pin is lower than 0.4V, the device enters shutdown mode and the switch FET is turned off.

APPLICATION INFORMATION

The SGM3753 is a 38V high-efficiency and low EMI Boost DC/DC converter, which supports dimming by changing the duty cycle of the PWM signal applied to CTRL pin. The stable dimming range is 0.2% to 100%. The device has excellent line regulation, load regulation and transient response performance. It can be widely used in various panel backlight lighting.

Design Requirements

In this design example, Table 1 lists the operating conditions. The LED array adopts 10S1P, and the output current of each string of LED is 20mA.

Table 1. Design Parameters

DESIGN PARAMETER	EXAMPLE VALUE
Input Voltage Range	2.7V to 5.5V
Output, LED Number per String	10
Output, LED String Number	1
Output, LED Current per String	20mA

Inductor Selection

Inductance is an important power device for Boost converter design. Selecting appropriate inductor parameters can ensure that the system has high efficiency and stable steady-state performance. At the same time, it will also affect the system transient response and loop stability. Inductor's DC resistance, saturation current and inductance are important specs for DC/DC design. Large inductance results in small ripple current, which is beneficial to smaller output ripple voltage and higher transmission efficiency. Use Equation 3 to calculate the average inductor current $I_{L(DC)}$:

$$I_{L(DC)} = \frac{V_{OUT} \times I_{OUT}}{V_{IN} \times \eta} \quad (3)$$

where

V_{OUT} = Boost output voltage

I_{OUT} = Boost output current

V_{IN} = Boost input voltage

η = power conversion efficiency.

Use the minimum input voltage, maximum output voltage, and maximum load current to calculate the worst-case average current. The selected inductor should provide a peak to peak ripple current $\Delta I_{L(P-P)}$ to be 30% to 40% of inductor average DC current $I_{L(DC)}$ calculated in Equation 3. Use Equation 4 to calculate the peak-to-peak inductor current.

$$\Delta I_{L(P-P)} = \frac{1}{L \times \left(\frac{1}{V_{OUT} - V_{IN}} + \frac{1}{V_{IN}} \right) \times f_s} \quad (4)$$

where

$\Delta I_{L(P-P)}$ = Inductor peak-to-peak ripple

L = Inductor value

f_s = Boost switching frequency

V_{OUT} = Boost output voltage

V_{IN} = Boost input voltage

Use Equation 5 to calculate the peak inductor current.

$$I_{L(P)} = I_{L(DC)} + \frac{\Delta I_{L(P-P)}}{2} \quad (5)$$

The saturation current value of inductor will affect the operation of Boost converter. When the inductor current is close to or higher than the saturation current, the inductance will drop rapidly, which causes the peak inductor current to rise and reach the peak current limit of the IC. The selected inductor's saturation current should maintain a 20% margin, and a 10 μ H to 22 μ H inductor is recommended for SGM3753.

Schottky Diode Selection

In order to ensure the best efficiency of SGM3753, the selected Schottky diode should have low forward voltage, fast reverse recovery speed, and low junction capacitance. At the same time, the average and peak current ratings of the selected diode should exceed the average output current and peak inductor current. It is recommended to have a 20% current margin. Additionally, the Schottky diode reverse breakdown voltage should be higher than the open LED protection voltage threshold to avoid damage. It is recommended to use ONSem NSR0240 for the SGM3753.

APPLICATION INFORMATION (continued)

Output Capacitor Selection

The output capacitance of SGM3753 is used to meet the loop stability and output ripple requirement. At the same time, it affects the loop bandwidth and the transient response performance. MLCC capacitor with low ESR is recommended as the output capacitor. For a given output voltage ripple requirement, the minimum output capacitance value can be calculated according to Equation 6:

$$C_{OUT} = \frac{(V_{OUT} - V_{IN}) \times I_{OUT}}{V_{OUT} \times f_S \times V_{RIPPLE}} \quad (6)$$

where

V_{RIPPLE} = peak-to-peak output ripple.

A 1 μ F to 10 μ F MLCC capacitor is recommended for typical application. Since the reference voltage V_{REF} is obtained by filtering the pulse signal, the actual output ripple contains the pulsed ripple, which carries the same frequency as the PWM signal. The interference ripple can be effectively reduced by using 1 μ F MLCC capacitor. For higher total output current applications, it is recommended to use 2.2 μ F or larger MLCC output capacitor to minimize output ripple.

LED Current Set Resistor

Use Equation 1 to calculate the R_{SET} resistance. Multiple resistors can also be connected in parallel to obtain the required resistance value.

Thermal Considerations

Thermal dissipation of the IC should be considered to design the SGM3753. High IC junction temperature will trigger thermal shutdown. The heat loss is related to the system input and output. Lower input voltage and higher output current leads to more heat loss. The thermal dissipation can be reduced by reasonable layout. The allowable heat loss of device can be determined by Equation 7:

$$P_D = \frac{150^\circ\text{C} - T_A}{\theta_{JA}} \quad (7)$$

where

T_A = the ambient temperature for the application.

θ_{JA} = the thermal resistance junction-to-ambient given under absolute maximum ratings section.

Power Supply Recommendations

The SGM3753 operates with an input voltage range of 2.7V to 5.5V. It is recommended to use 22 μ F MLCC capacitor as the input capacitor. If the SGM3753 is located far away from the input power supply, an additional high-capacity capacitor is recommended to damp the wiring inductance.

EMI Precaution and Ringing Cancellation

Careful layout, routing and selection of decoupling components are critical to suppress EMI related noise.

Ways of EMI suppression include propagation limit and reduction of energy swings, such as inserting ferrite bead in power supply trace, selecting high self-resonance frequency decoupling capacitors and SW node ringing cancellation. Figure 4 is a simplified circuit showing that ringing is caused by diode's junction capacitance C_j and Boost inductor L , which injects current swings into power supply traces; the 2 voltage waveforms on the right illustrate the difference of circuit performance, with or without ringing cancellation.

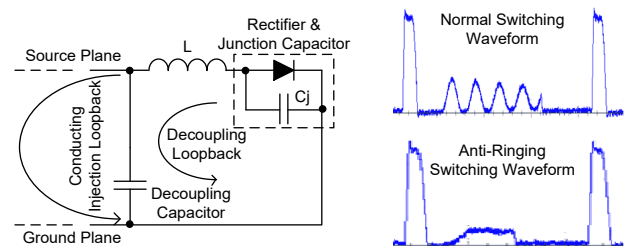

Figure 4. Ringing Cancellation Illustration

APPLICATION INFORMATION (continued)**Layout Considerations**

Layout design is an important step in all switching power supplies design. Good layout plays a positive role in loop stability, signal integrity and low EMI. Since the switch FET of SGM3753 works at a typical switching frequency of 600kHz, its power circuit layout needs to be designed more carefully. The SW node contains high dV/dt and di/dt switching. The area of SW node should be as small as possible, and the input and output loop needs to maintain the minimum loop path, which can effectively suppress the generation of ringing. For the high current path, it should be as wide and short as possible. The input capacitance C_{IN} should be close

to VIN pin and GND pin to reduce the influence of parasitic parameters on the line. The inductor and the Schottky diode should be placed close to the SW pin to reduce the area of the SW node, which reduces EMI. The output capacitance C_{OUT} should be as close to V_{OUT} as possible, and the ground of C_{OUT} should be close to GND pin to reduce grounding return. FB resistors should be placed close to FB pin. For signal grounding, it is recommended to route the ground signal away from the power ground plane with small and short traces, and connect the signal ground with power ground via a single point close to the GND pin.

REVISION HISTORY

NOTE: Page numbers for previous revisions may differ from page numbers in the current version.

SEPTEMBER 2022 – REV.A to REV.A.1	Page
Updated Description section.....	All
Changes from Original (JULY 2016) to REV.A	Page
Changed from product preview to production data.....	All

PACKAGE OUTLINE DIMENSIONS

TDFN-2x2-6L

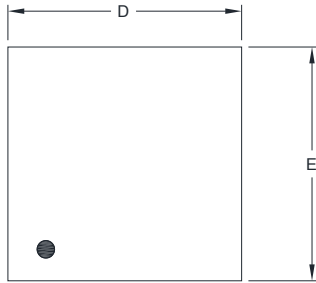

TOP VIEW

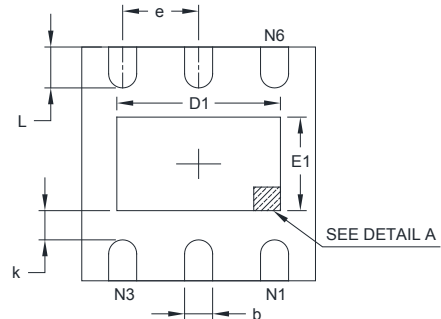

BOTTOM VIEW

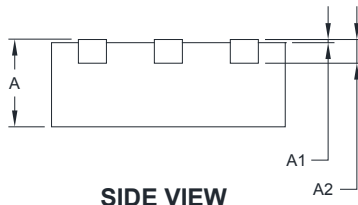

SIDE VIEW

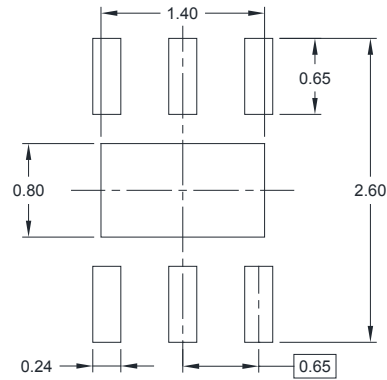

RECOMMENDED LAND PATTERN (Unit: mm)

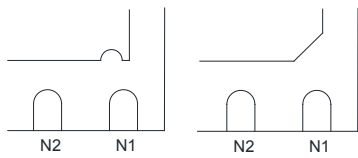

DETAIL A

Pin #1 ID and Tie Bar Mark Options

NOTE: The configuration of the Pin #1 identifier is optional, but must be located within the zone indicated.

Symbol	Dimensions In Millimeters		Dimensions In Inches	
	MIN	MAX	MIN	MAX
A	0.700	0.800	0.028	0.031
A1	0.000	0.050	0.000	0.002
A2	0.203 REF		0.008 REF	
D	1.900	2.100	0.075	0.083
D1	1.100	1.450	0.043	0.057
E	1.900	2.100	0.075	0.083
E1	0.600	0.850	0.024	0.034
k	0.200 MIN		0.008 MIN	
b	0.180	0.300	0.007	0.012
e	0.650 TYP		0.026 TYP	
L	0.250	0.450	0.010	0.018

PACKAGE INFORMATION

TAPE AND REEL INFORMATION

REEL DIMENSIONS



TAPE DIMENSIONS



NOTE: The picture is only for reference. Please make the object as the standard.

KEY PARAMETER LIST OF TAPE AND REEL

Package Type	Reel Diameter	Reel Width W1 (mm)	A0 (mm)	B0 (mm)	K0 (mm)	P0 (mm)	P1 (mm)	P2 (mm)	W (mm)	Pin1 Quadrant
TDFN-2×2-6L	7"	9.5	2.30	2.30	1.10	4.0	4.0	2.0	8.0	Q1

DD0001

PACKAGE INFORMATION

CARTON BOX DIMENSIONS



NOTE: The picture is only for reference. Please make the object as the standard.

KEY PARAMETER LIST OF CARTON BOX

Reel Type	Length (mm)	Width (mm)	Height (mm)	Pizza/Carton
7" (Option)	368	227	224	8
7"	442	410	224	18

DD0002